



CT4i Operator's Manual

For printer models:

CT 408i/412i/424i



Read this Operator's Manual before and during usage of the above product. Keep this document handy for future reference.

**Be sure to ask your dealer about our maintenance contracts
to ensure peace of mind during your usage of SATO products**

Version: SI-CT4xxi-01rA-21-12-07OM

© Copyright 1994 – 2007

SATO International

Warning: This equipment complies with the requirements in Part 15 of FCC rules for a Class A computing device. Operation of this equipment in a residential area may cause unacceptable interference to radio and TV reception requiring the operator to take whatever steps are necessary to correct the interference.

All rights reserved. No part of this document may be reproduced or issued to third parties in any form whatsoever without the express permission of SATO. The materials in this document are provided for general information and are subject to change without notice. SATO assumes no responsibilities for any errors that may appear.

WARNING

THE EQUIPMENT REFERENCED IN THIS DOCUMENT COMPLIES WITH THE REQUIREMENTS IN PART 15 OF FCC RULES FOR A CLASS B COMPUTING DEVICE. OPERATION OF THIS EQUIPMENT IN A RESIDENTIAL AREA MAY CAUSE UNACCEPTABLE INTERFERENCE TO RADIO AND TV RECEPTION.

Contact and Document Information

SATO GROUP OF COMPANIES	
International Headquarters	Americas
<p>SATO INTERNATIONAL PTE. LTD 438A Alexandra Road #05-01/04, Alexandra Technopark, Singapore 119967 Phone: 65-6271-2122 Fax: 65-6271-2151 Email: sales@sato-int.com</p>	<p>SATO INTERNATIONAL AMERICA, INC. (Regional HQ) 10350 Nations Ford Road Suite A, Charlotte, NC 28273 Phone: 1-704-644-1650 Fax: 1-704-644-1662 Email: satosales@satoamerica.com</p>
Americas	
<p>SATO AMERICA, INC. 10350 Nations Ford Road Suite A, Charlotte, NC 28273 Phone: 1-704-644-1650 Fax: 1-704-644-1662 Email: satosales@satoamerica.com</p>	<p>SATO LABELING SOLUTIONS AMERICA, INC. 1140 Windham Parkway, Romeoville, Illinois 60446 Phone: 630-771-4200 Fax: 630-771-4210 Email: sales@sato labeling.com</p> <p>Horticultural Division 930 Jimmy Ann Drive Daytona Beach, FL 32117 Phone: 1-386-274-5566 Fax: 1-386-274-5599</p>
Europe	
<p>SATO INTERNATIONAL EUROPE N.V. (Regional HQ) Leuvensesteenweg 369, 1932 Sint-Stevens-Woluwe, Brussels, Belgium Phone: 32(0)-2-788-80-00 Fax: 32(0)-2-788-80-80 Email: info@be.sato-europe.com</p>	<p>SATO UK LTD Valley Road, Harwich, Essex England Co12 4RR, United Kingdom Phone: 44-1255-240000 Fax: 44-1255-240111 Email: enquiries@satouk.com</p>
<p>SATO LABELLING SOLUTIONS EUROPE GmbH Ersheimer Straße 71, 69434 Hirschhorn, Germany Phone: 49-6272-9201-324 Fax: 49-6272-9201-399</p>	<p>SATO POLSKA SP Z O.O. Ul. Wroclawska 123, 55-015 Radwanice K/Wroclawia, Poland Phone: 48-71-381-03-60 Fax: 48-71-381-03-68 Email: info@sato-europe.com</p>
<p>SATO FRANCE SAS Parc D'Activites - Rue Jacques Messager - 59175 Templemars, France Phone: 33-3-20-62-96-40 Fax: 33-3-20-62-96-55</p>	<p>SATO IBERIA S.A. Dels Coralls Nous, 35-39, Pol. Can Roqueta, 08202 - Sabadell, Barcelona, Spain Phone: 34-93-492-5750 Fax: 34-93-786-3451</p>
Asia Pacific & Oceania	
<p>SATO INTERNATIONAL ASIA PACIFIC PTE. LTD. (Regional HQ) 438A Alexandra Road #05-01/04, Alexandra Technopark, Singapore 119967 Phone: 65-6271-5300 Fax: 65-6273-6011 Email: sales@sato-int.com</p>	<p>SATO AUTO-ID MALAYSIA SDN. BHD. No.25, Jalan Pemberita U1/49, Temasya Industrial Park Section U1, 40150 Shah Alam, Selangor Darul Ehsan, Malaysia Phone: 60-3-7620-8901 Fax: 60-3-5569-4977 Email: sales@satosms.com.my</p>
<p>SATO ASIA PACIFIC PTE. LTD. 438A Alexandra Road #05-01/04, Alexandra Technopark, Singapore 119967 Phone: 65-6271-5300 Fax: 65-6273-6011 Email: sales@satoasiapacific.com</p>	<p>SATO AUTO-ID (THAILAND) CO., LTD. 292/1 Moo 1 Theparak Road, Tumbol Theparak, Amphur Muang, Samutprakarn 10270 Phone: 662-736-4460 Fax: 662-736-4461</p>
<p>SATO SHANGHAI CO., LTD. 307 Haining Road, ACE Bldg, 10th Floor, Hongkou Area, Shanghai, China 200080 Phone: (86) 021- 63068899 Fax: (86) 021- 63091318</p>	<p>SATO AUSTRALIA PTY LTD. 1/1 Nursery Avenue, Clayton Business Park (1508 Centre Road) Clayton VIC 3168, Melbourne, Australia Phone: 61-3-8814-5330 Fax: 61-3-8814-5335</p>
<p>SATO NEW ZEALAND LTD 30 Apollo Drive, Mairangi Bay PO Box 305-031, North Shore, Auckland, New Zealand Phone: 64-9-477-2222 Fax: 64-9-477-2228</p>	<p>For a full list of all SATO offices, refer to www.satoworldwide.com</p>

Extensive contact information of worldwide SATO operations can be found on the Internet at
www.satoworldwide.com

This page is intentionally left blank.

TABLE OF CONTENTS

INTRODUCTION	1-1
About this manual	1-2
General Description	1-3
TECHNICAL DATA	2-1
Interface Selection	2-6
RS232C high-speed Serial Interface (25-pin)	2-6
IEEE1284 Parallel Interface	2-8
Universal Serial Bus (USB).....	2-9
Bluetooth.....	2-9
Local Area Network (LAN) Ethernet.....	2-10
802.11G Wireless	2-11
All Interfaces	2-13
ACK/NAK Protocol.....	2-13
Status5 Return	2-13
INSTALLATION	3-1
Overview	3-2
Unpacking & Parts Identification	3-5
Printer Installation	3-6
Site Location	3-6
Media Selection	3-6
Media Loading: Rolled Paper.....	3-6
Ribbon Loading	3-7
Loading Fanfold Paper.....	3-8
Label Sensing	3-9
Operational Mode Selection.....	3-10
Continuous Mode.....	3-10
Tear-off Mode	3-10
Cutter Mode	3-10
Dispense Mode	3-10
Linerless Mode.....	3-10
PRINTER CONFIGURATION	4-1
Configuration Modes	4-2
Operating Panel	4-2
The Rear Panel	4-3
The Configuration Panel	4-4
Operational Modes.....	4-8
Adjustment of Reference Print position.....	4-16
Potentiometer Adjustments	4-18
Printing Test Labels	4-20
Printing Factory/Service Test Prints.....	4-21

TROUBLESHOOTING	5-1
Troubleshooting Guide.....	5-2
Interface Troubleshooting	5-6
Test Print Troubleshooting	5-8
Hex Dump	5-8
Test Label Printing	5-8
 MAINTENANCE	 6-1
Cleaning procedures	6-2
Adjustment Procedures.....	6-3
Adjusting the Print Quality.....	6-3
Cleaning the Print Head, Platen and Rollers.....	6-4
Releasing/Replacing the Print Head	6-6
Cleaning the Sensor.....	6-7

1

INTRODUCTION

- **About This Manual**
- **General Description**
- **Control Features**

ABOUT THIS MANUAL

This manual is laid out consistent with the product discussed and provides all of the information required for printer installation, configuration, operation, and light maintenance. Refer to this product's Programming Reference document for instructions on printer programming through a host system.

This manual also incorporates the use of special information boxes. Examples of these boxes and the type of information provided in each, are below.

WARNING: PROVIDES INFORMATION THAT, IF UNHEEDED, MAY RESULT IN PERSONAL INJURY.

CAUTION: PROVIDES INFORMATION THAT, IF UNHEEDED, MAY RESULT IN EQUIPMENT DAMAGE.

ATTENTION: Provides information that is deemed of special importance but will not result in personal injury or product damage if unheeded.

NOTE: Provides helpful hints to assist in performing the tasks at hand.

LCD DISPLAY: Provides the specific display that should be visible on the LCD at that point.

A comprehensive Table Of Contents provided at the front of this manual facilitates rapid movement within. The contents identify the different Units, Chapters, and some Sections. Each references the page number of their commencement.

The pages of this manual have embedded headers and footers to assist the user in identifying his or her exact position within the manual. The header provides the unit number followed by its name. The footer identifies the product on the left, the page number in the center, and the manual's part number to the right side of the page.

Page enumeration is two-part with each separated by a hyphen. The first character set references the Unit and the second identifies the page number within that unit. Page numbers begin with the numeral one (1) at the beginning of a new unit and ascend sequentially.

GENERAL DESCRIPTION

The compact CT4i Series printers are designed for use in medium-volume labeling applications demanding a low footprint, crisp print quality of up to 600dpi; hardware versatility, ease of use, and great reliability. Its antibacterial chassis also positions it ideally for clinical environments. The printer's main parts are described below.

Figure 1-1, Primary Parts (Direct Thermal model)

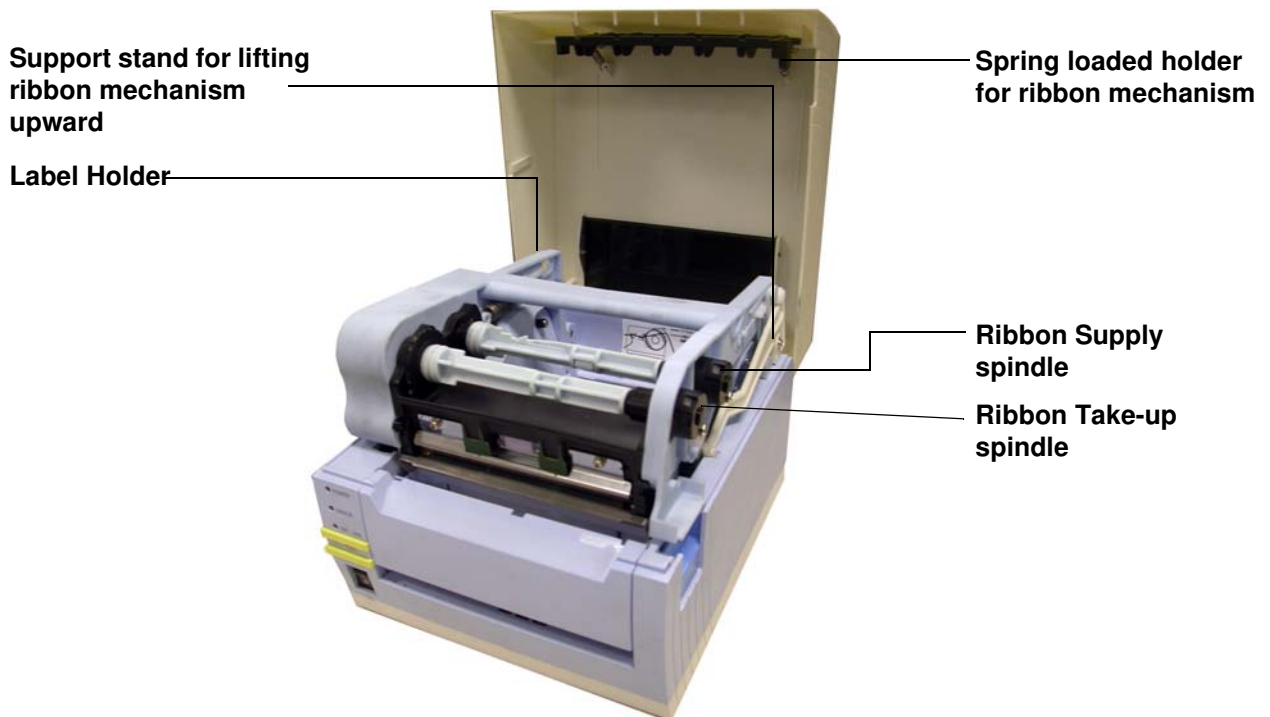
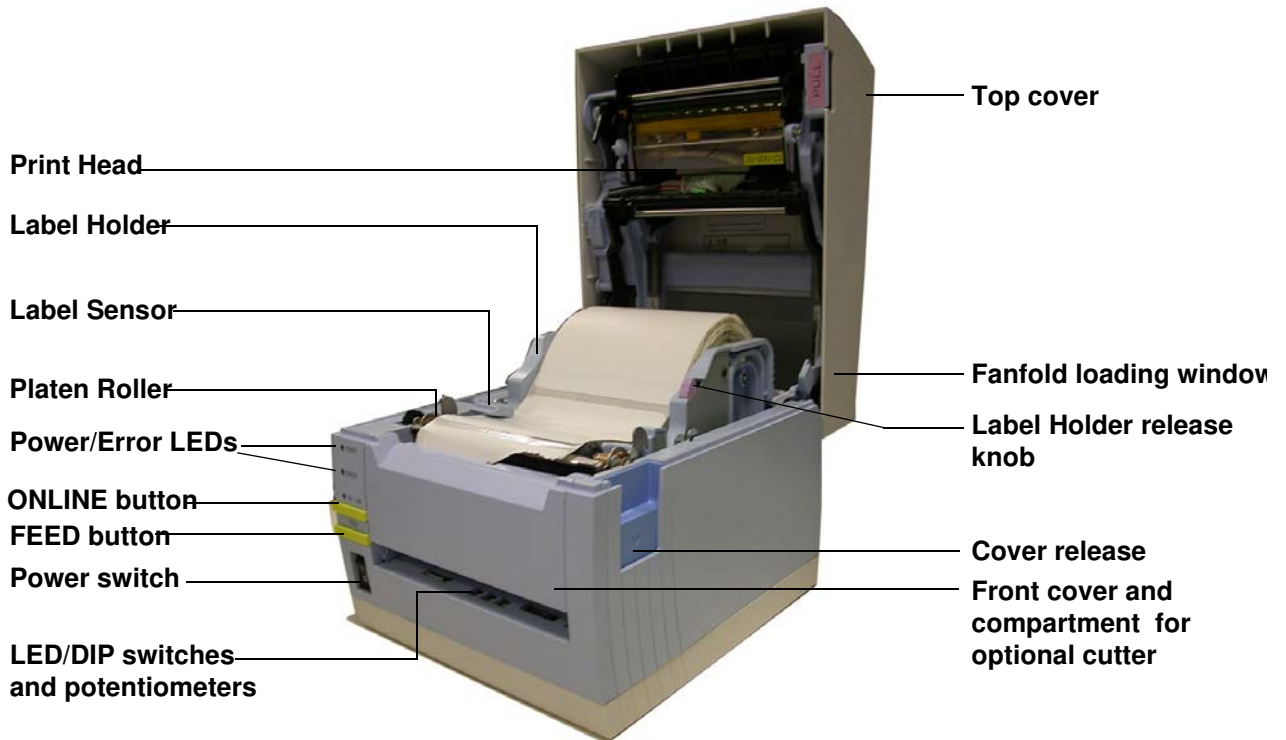

Figure 1-2, Primary Parts (Thermal Transfer model)

Unit 1: Introduction

This page is left blank intentionally.

2

TECHNICAL DATA

- **Physical Characteristics**
- **Environmental Specs**
- **Power Supply**
- **Processing**
- **Printer Language**
- **Interface Modules**
- **Print**
- **Sensing**
- **Media**
- **Ribbon**
- **Regulatory Approvals**
- **Character Font Capabilities**
- **Barcode Capabilities**

Unit 2: Technical Data

PHYSICAL CHARACTERISTICS	
Width	7.8 in. (198 mm)
Height	8.8 in. (225 mm)
Depth	7.1 in. (181 mm)
Weight	5.5 lbs (2.5 Kg) excluding AC adaptor

ENVIRONMENTAL (EXCLUDING MEDIA)	
Operating Temperature/Humidity	5° to 35°C @ 30 to 80%RH
Storage Temperature/Humidity	-5° to 60°C @ 30 ~ 90%RH, non-condensing (NA for media)

POWER SUPPLY	
Input Voltage (AC)	100-240 Volts AC +/- 10%, 50/60 Hertz Rated Input voltage: 25 V DC Rated current: 1.5 A
Input Voltage (DC)	Rated voltage: 24.0 VDC - 25.25 VDC Rated current: 2 A (Current peak: 13 A)
Power Consumption	90 Watts (when print ratio is 30%)

PROCESSING	
CPU	32 Bit RISC
Flash ROM	4 Megabytes
SDRAM	16 MB

PRINTER LANGUAGE	
Standard	SATO Barcode Printer Language (SBPL) 4.3

INTERFACES	
Standard configurations	Either 1) USB 2.0 with RS-232C or 2) USB 2.0 with LAN (10BASE-T/100BASE-TX Automatic Switching)
User installable Optional Interface Board (USB with RS232C model only)	IEEE1284, 802.11g Wireless Wi-Fi, Bluetooth

Unit 2: Technical Data

PRINT	
Method	DT models: Direct Thermal only TT models: Thermal Transfer and Direct Thermal (switchable)
Maximum Speed (selectable)	2, 3, 4, 5, 6 Inches Per Second (CT408i) 2, 3, 4 Inches Per Second (CT412i) 2, 3 Inches Per Second (CT424i)
Resolution	CT408i: 203 Dots Per Inch (8 dpmm) CT412i: 305 Dots Per Inch (12 dpmm) CT424i: 600 Dots Per Inch (23.6 dpmm)
Maximum Print Width	104 mm
Maximum Print Length	400 mm
SENSING	
Gap	Sensitivity Adjustable
Reflective Eye-Mark	Sensitivity Adjustable
Head Open	Fixed
Media Out	Fixed (always enabled)
Ribbon Out	Fixed (always enabled)
MEDIA	
Width	Media Width: 1 - 4.6 inches (25 - 115 mm) (28 - 118 mm with backing paper) Note: For Dispensing Mode, specifications may vary depending on the requirements
Length	0.6 - 15.66 inches (15 - 397 mm) With backing paper: 0.72 - 16 inches (18 - 400 mm)
Type	Direct Thermal / Thermal Transfer depending on print model (DT or TT) Roll stock / Fan-fold
Configuration	Roll stock: Max. outer diameter: 4.4 inches (110 mm) Wound face-out, Inner diameter of roll: 1.6 inches (40 mm) Fanfold: Max. stack height: 4 inches (100 mm) (external supply)
Thickness	0.0032 - 0.0076 inches (0.08 - 0.19 mm)
Wind Direction	Face Out
RIBBON	
Width	4.44 inches (111 mm)
Length	3937 inches (100 M)
Wound	Face Out
Core Diameter	0.508 inches (12.7 mm)

Unit 2: Technical Data

REGULATORY	
USA/Canada	UL60950-1(2001), CSA C22.2 No.60950-1-03
China	CCC (GB4943-2001)
EU	CE, Nemko (EN60950-1)
Singapore	SS337:2001
Korea	MIC, EK (only AC-Adapter applicable)
Radiation Noise	FCC Part 15, Subpart B, Class B (USA/Canada) GB9254-1998, GB17625.1-2003 (China) CE (EN55022, EN55024, EN61000-3-2/-3) (EU) CISPR22, CISPR24 (reference standard, Singapore) KN22, KN24 (Korea)
WLAN/RFID/Bluetooth	FCC15B / FCC15C (USA/Canada) SRRC (China) Wireless LAN/Bluetooth (2.45GHz) R&TTE (EN300 328 V1.4: 2003-04, EN301 489 V1.4.1: 2002-08); HF Band: RFID (13.56MHz) (EU) R&TTE (EN300-330) IDATS (Singapore) MIC (Korea)
Antibacterial Finish	JISZ2801 (control panel and enclosure)
Environmental (RoHS)	Chromium: below 0.1% Lead: below 0.1% Mercury: below 0.1% Cadmium: below 0.01% Polybrominated Biphenyl (PBB): below 0.1% Polybrominated Diphenyl Ether (PBDE): below 0.1%

CHARACTER FONT CAPABILITIES	
MATRIX FONTS	
XU	5 dots W x 9 dots H (Helvetica)
XS	17 dots W x 17 dots H (Univers Condensed Bold)
XM	24 dots W x 24 dots H (Univers Condensed Bold)
OA Font (OCR-A)	CT408i: 15 dots W x 22 dots H CT412i: 22 dots W x 33 dots H CT424i: 44 dots W x 66 dots H
OB Font (OCR-B)	CT408i: 20 dots W x 24 dots H CT412i: 30 dots W x 36 dots H CT424i: 60 dots W x 72 dots H
AUTO SMOOTHING FONTS	
XB	48 dots W x 48 dots H (Univers Condensed Bold)
XL	48 dots W x 48 dots H (Sans Serif)
DOWNLOADABLE FONTS	
	Up to 1600 characters of 64 bit x 64 bit sized font can be downloaded to Flash Memory
	Expansion up to 12 x in either the X or Y coordinates. Character Pitch Control Line Space Control Journal Print Facility 0, 90, 180, and 270-degree rotation

Unit 2: Technical Data

BARCODE CAPABILITIES	
Linear Bar Codes	UPC-A/E, EAN, CODABAR, CODE39, CODE93, CODE128, UCC/EAN128, Interleaved 2of5, Industrial 2of5, Matrix 2of5, MSI, BOOKLAND, POSTNET, EAN/UCC symbol
Two Dimensional	QR code (Ver8.1), PDF417 (Ver2.4), MAXI code (Ver3.0), Data Matrix (Ver1.3) *Only ECC200 is supported
Ratios	1:2, 1:3, 2:5, User definable bar widths
Bar Height	4 to 999 dots, User programmable
Rotation	0, 90, 180, and 270 Degrees

INTERFACE SELECTION

This unit presents the printer interface types and their specifications. These specifications include detailed information to assist in the selection of the most appropriate method for the printer to interface with the host. The five acceptable interface methods are:

- RS232C High-Speed Serial
- IEEE1284 Parallel
- Universal Serial Bus (USB)
- Bluetooth
- Local Area network (LAN) Ethernet
- 802.11g Wireless

Following the selection of the desired interface, proceed to the next unit for instructions on how to configure the printer for that interface type.

WARNING: NEVER CONNECT OR DISCONNECT INTERFACE CABLES (OR USE A SWITCH BOX) WITH POWER APPLIED TO EITHER THE HOST OR THE PRINTER. THIS MAY CAUSE DAMAGE TO THE INTERFACE CIRCUITRY IN THE PRINTER/HOST AND IS NOT COVERED BY WARRANTY.

RS232C HIGH-SPEED SERIAL INTERFACE (25-PIN)

INTERFACE SPECIFICATIONS	
Asynchronous ASCII	Half-duplex communication Bi-Directional Communication
Data Transmission Rate	9600, 19200, 38400, 57600 bps
Transmission Form	Start, b1, b2, b3, b4, b5, b6, b7, b8, Stop (b8 will be omitted if using 7 bit oriented)
Data Length	7 or 8 bit (selectable)
Stop Bit	1 or 2 bit (selectable)
Parity Bit	ODD, EVEN, NONE (selectable)
Codes Used	ASC II Character Codes: 7 bits, Graphics: 8 bits
Control Codes	STX (02H), ETX (03H), ACK (06H), NAK (15H)
Connector (Printer Side)	DB-25 Male (equivalent)
Cable Connector	DB-25 Female (equivalent)
Cable Length	5 meters or less.
Signal Levels	High = +5V to +12V, Low = -5V to -12V
Protocol	Ready/Busy, X-On/X-Off, Protocol for Driver, Status2, Status3, Status4, Status5

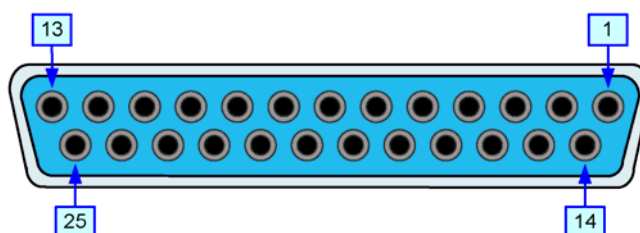

Figure 3-5, Serial Connector Pin Assignments

Unit 2: Technical Data

I/O SIGNALS			
PIN#	SIGNAL	I/O	DESCRIPTION
1	FG	-	Framework Ground
2	SD	Output	Data transferred from Printer to Host
3	RD	Input	Data transferred from Host to Printer
4	RS	Output	Goes to the Low state when an error occurs in the printer
5	CS	Input	Maintained at the High state
6	DR	Input	Maintained at the High state
7	SG	-	Signal Ground
20	ER	Output	Goes to the High state when printer is ready to receive data Goes Low when printer is OFFLINE or errors have occurred in the printer

LINE CONNECTION				
DB9	DB25	HOST	INTERCONNECTION	PRINTER
1	1	FG	←————→	1 FG (Frame Ground)
2	3	RD	←————	2 TD (Transmit Data)
3	2	TD	————→	3 RD (Receive Data)
8	5	CTS	←————	4 RTS (Request To Send)
7	4	RTS	————→	5 CTS (Clear To Send)
4	20	DTR	————→	6 DSR (Data Set Ready)
6	6	DSR*	←————	20 DTR (Data Terminal Ready)
5	7	SG	←————→	7 SG (Signal Ground)

IEEE1284 PARALLEL INTERFACE

The parallel interface is a plug-in module that can be installed by the user and conforms to IEEE1284 specifications. It automatically detects the IEEE1284 signals and operates in the high speed mode. If the IEEE1284 signals are not detected, it will operate in the slower standard Centronics mode. For this reason, an interface cable and host interface conforming to the IEEE1284 specification must be present to fully utilize the speed capabilities. This interface also operates bi-directionally and can report the status of the printer back to the host.

SPECIFICATIONS	
Printer Connector	AMP 57-40360 DDK (or equivalent)
Cable Connector	AMP 57-30360 DDK (or equivalent)
Cable	1.5 meter or less
Signal Level	High = +2.4V to +5.0V, Low = 0V to -0.4V
Data Stream	<ESC>A . . Job#1 . . <ESC>Z<ESC>A . . Job#n . . <ESC>Z

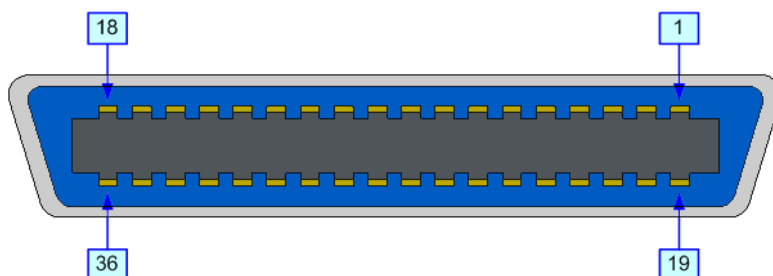

Figure 3-6, Parallel Connector Pin Assignments

PIN ASSIGNMENTS					
PIN	SIGNAL	DIRECTION	PIN	SIGNAL	DIRECTION
1	Strobe	To Printer	19	Strobe Return	Reference
2	Data 1	To Printer	20	Data 1 Return	Reference
3	Data 2	To Printer	21	Data 2 Return	Reference
4	Data 3	To Printer	22	Data 3 Return	Reference
5	Data 4	To Printer	23	Data 4 Return	Reference
6	Data 5	To Printer	24	Data 5 Return	Reference
7	Data 6	To Printer	25	Data 6 Return	Reference
8	Data 7	To Printer	26	Data 7 Return	Reference
9	Data 8	To Printer	27	Data 8 Return	Reference
10	ACK	To Host	28	ACK Return	Reference
11	Busy	To Host	29	Busy Return	Reference
12	Ptr Error	To Host	30	PE Return	Reference
13	Select	To Host	31	INIT	From Host
14	AutoFD1	To Host	32	Fault	To Host
15	Not Used		33	Not Used	
16	Logic Gnd		34	Not Used	
17	FG	Frame Gnd	35	Not Used	
18	+5V (z=24k ohm)	To Host	36	SelectIn1	From Host

1 Signals required for IEEE 1284 mode.

Unit 2: Technical Data

UNIVERSAL SERIAL BUS (USB)

The Universal Serial Bus (USB) interface is a Plug-In Interface Module that can be installed by the user. It requires a driver (shipped with each printer that has the interface installed) that must be loaded onto the PC and configured to support USB peripherals using Windows 2000 or above. Details for loading the USB driver are contained in the USB Interface Manual that is shipped with each printer with a USB Optional interface installed. Up to 127 devices may be connected to a USB port using powered hubs.

ATTENTION: This Interface Type Is Not Compatible With Windows 98 Or Windows Me.

SPECIFICATIONS	
Printer Connector	USB Type B Plug
Connector Pin Assignment	Pin 1 (VBus), Pin 2 (D- or -Data), Pin 3 (D+ or +Data), Pin 4 (GND)
Cable	5 M or less (Twisted Pair Shielded)
Host	Windows 2000 or above with USB Port
Power Supply	BUS Power through cable
Power Consumption	+5 V at 80 ma

BLUETOOTH

The Bluetooth interface on the CT4i printer complies with the Bluetooth 1.1 Class 2 standard. The Bluetooth interface and the printer are connected by a serial interface at a transfer rate of 115200bps.

SPECIFICATIONS	
Profile	Serial Port Profile (virtual serial port is established and two devices compatible with Bluetooth are connected.)
Operation Mode	Slave Mode
Interface Type selection	Turn DSW8 to OFF for extended interface (DSW8 = ON is for USB/RS-232C/IEEE1284)
Security Mode	- Level 1 No authentication - Level 2 PIN code authentication, Service level, No encryption - Level 2 PIN code authentication, Service level, Encryption - Level 3 PIN code authentication, Link level
Packet Type	DM5
PIN Code	16-digit ASCII code
Power Saving Mode	sniff, park, hold
Communication TimeOut/Retry	10 seconds (fixed)/1 second (recommended retry value)
Code	ASCII (7 bits), Graphic (8 bits)
SR mode value	R1

Unit 2: Technical Data

LOCAL AREA NETWORK (LAN) ETHERNET

A Local Area Network (LAN) interface is an optional Plug-In Interface Module that can be installed by the user. It requires a driver shipped with each printer that has the interface installed. The driver that must be loaded onto the host computer and configured to run one of the supported network protocols using a 10Base-T or 100Base-TX LAN connection. Details for loading the LAN driver are contained in the LAN Interface Manual that is shipped with each printer with a LAN Optional interface installed.

SOFTWARE SPECIFICATIONS	
Corresponding Protocol	TCP/IP
Network Layer	ARP, RARP, IP, ICMP
Session Layer	TCP, UDP
Application Layer	LPD, FTP, TELNET, BOOTP, DHCP
<i>NOTE: Print data can be sent by LPR and FTP of TCP/IP and dedicated socket protocol. Printer status is obtainable by dedicated socket protocol.</i>	
<i>NOTE: In the TCP/IP protocol environment, LPD and FTP are provided for printing; TELNET for variable setup; ARP, RARP, and BOOTP/DHCP for address setup.</i>	
<i>LPD protocol complies with RFC1179 and handles the list of logical printer name as queue name such as lp, sjis, euc. In addition, a banner page can be printed by a proper setup.</i>	
<i>When sending the job by LPR, the transmission order of data file/control file within the job will not affect print operation. In addition, if the banner page is specified, it will be added to each data file. Job deletion by LPR is not available.</i>	
<i>FTP protocol complies with RFC959 and handles the list of logical printer name as a transfer directory. File transfer to this directory executes print operation. It is possible to specify ASCII(A), Binary(I) and TENEX(L8) as transfer mode - although the mode difference is dependent on the client. A banner page may be printed with a proper setup.</i>	
<i>TELNET Complies with RFC854. This operation consists of interactive menu form and enables change and reference of internal setup, and to display status. To change the setup, enter "root" user and password at the time of login. Default of root password is set as null (linefeed only).</i>	

SPECIFICATIONS	
Connector	RJ-45 Receptacle
Cable	10/100BaseT Category 5
Cable Length	100 meters or less
Power Supply	Powered from printer
Protocol	Status3 return Protocol for Driver (cyclic response mode) Protocol for Driver (ENQ response mode) Status5 return
IP Address	0.0.0.0 to 255.255.255.255
Subnet Mask	0.0.0.0 to 255.255.255.255
Gateway Address	0.0.0.0 to 255.255.255.255

Unit 2: Technical Data

802.11G WIRELESS

The wireless print server provides easy printer interface with 802.11g Wi-Fi compliant networks free of wired connections. Each printer is shipped with an integrated driver and interface installed. The driver must be loaded onto the host computer and configured to run one of the supported protocols.

SPECIFICATIONS	
Variable Data Rates	54, 11, 5.5, 2 and 1 Mbps
Frequency Band	2.4 GHz ISM Band
Wired Equivalent Privacy	128 bit, 64 bit (compatible with 40bit), none (WPA)
Sensitivity	(typ, AAWGN, 8E-2 PER): -91dBm at 1Mbps, -88dBm at 2 Mdps, -87dBm at 5.5Mbps, -84dBm at 11Mbps.
Range	100m indoors, 300m outdoors (environmentally dependent)
Protocols	TCP/IP, IPX/SPX, Direct Mode IPX/IP, DLC/LLC, NetBEUI, NetBIOS/IP
Protocol	Status3 return Protocol for Driver (cyclic response mode) Protocol for Driver (ENQ response mode) Status5 return
IP Address	0.0.0.0 to 255.255.255.255
Subnet Mask	0.0.0.0 to 255.255.255.255
Gateway Address	0.0.0.0 to 255.255.255.255
Communication Mode	802.11 Ad hoc, Ad hoc, Infrastructure
SSID	Optional alphanumeric character string (up to 32 characters)
Channels	01 to 14 (Default = 11)

LED INDICATOR STATUS			
Link LED (green)	Network Port	Off	---
	Front Panel	Blinking	Waiting for link
		On	Linked
Status LED (orange)	Network Port	Off	---
	Front Panel	Blinking	Receiving packet
Wireless LED (green)	Front Panel	Blinking	Ad-hoc mode
		On	Infrastructure mode

WIRELESS LAN SIGNAL STRENGTH			
Network Port	Link LED	Off	0 to 50% (weak)
		Blinking	50 to 75% (medium)
		On	75 to 100% (strong)

SOFTWARE SPECIFICATIONS	
Corresponding Protocol	TCP/IP
Network Layer	ARP, RARP, IP, ICMP
Session Layer	TCP, UDP
Application Layer	LPD, FTP, TELNET, BOOTP, DHCP
NOTE: Print data can be sent by LPR and FTP of TCP/IP and dedicated socket protocol. Printer status is obtainable by dedicated socket protocol.	

SOFTWARE SPECIFICATIONS

NOTE: In the TCP/IP protocol environment, LPD and FTP are provided for printing; TELNET for variable setup; ARP, RARP, and BOOTP/DHCP for address setup.

LPD protocol complies with RFC1179 and handles the list of logical printer name as queue name such as lp, sjis, euc. In addition, a banner page can be printed by a proper setup.

When sending the job by LPR, the transmission order of data file/control file within the job will not affect print operation. In addition, if the banner page is specified, it will be added to each data file. Job deletion by LPR is not available.

FTP protocol complies with RFC959 and handles the list of logical printer name as a transfer directory. File transfer to this directory executes print operation. It is possible to specify ASCII(A), Binary(I) and TENEX(L8) as transfer mode - although the mode difference is dependent on the client. A banner page may be printed with a proper setup.

TELNET Complies with RFC854. This operation consists of interactive menu form and enables change and reference of internal setup, and to display status. To change the setup, enter "root" user and password at the time of login. Default of root password is set as null (linefeed only).

1) Printing by socket (Protocol for driver)

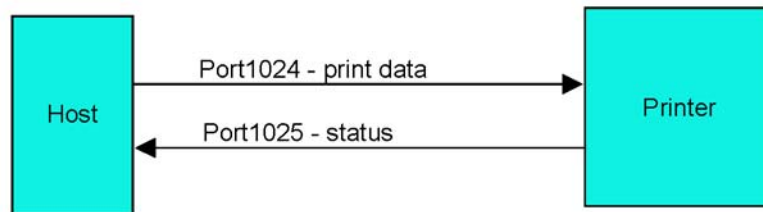

2) Printing by LPR and FTP

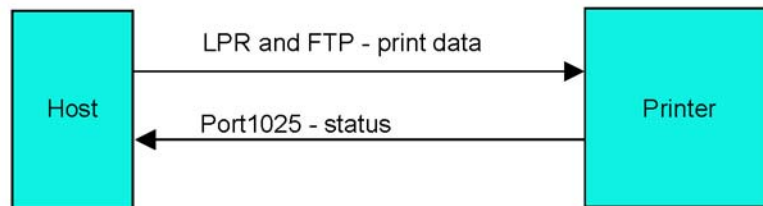

Figure 3-7, Socket Connection Diagram

ALL INTERFACES

Receive Buffer

The data stream is received from the host to the printer one job at a time. This allows the software program to maintain control of the job print queue so that it can move a high priority job in front of ones of lesser importance. A multiple job buffer allows the printer to continuously receive print jobs while compiling and printing other jobs at the same time. It acts much like a Print buffer to maximize the performance of the host and the printer.

The printer receives and prints one job at a time. If a print job exceeds the buffer size, transmission will be rejected by the printer. Error conditions that occur during the Print Data transmission will cause the printer to return a NAK.

ACK/NAK Protocol

Bi-Directional ACK/NAK protocol is used for error control. In a normal transmission sequence when the transmission is received, the printer will return an ACK (06H) signifying that it was received without a transmission error. After the transmission command structure has been analyzed, a status byte is returned to the host. This status byte informs the host of the validity of the command structure.

If the command structure is error free, the printer proceeds with the print operation. When the print operation is completed, a Printer Status message is returned to the host. If an error was detected during the initial transmission sequence, a NAK (15H) will be returned signalling to the host that the received transmission contained errors and must be resent. If the returned Status byte indicates a command structure error, the error must then be corrected before the print data is resent to the printer.

A valid transmission to the printer must be bounded by an STX/ETX pair, with the STX (02H) signifying the start of the Print Data and ending with an ETX (03H) signifying the end.

Status5 Return

This communication protocol is designed for the purpose of monitoring and controlling print data status in the host and featuring various functions.

INTERFACE SIGNALS	
SIGNAL	SIGNAL DEFINITION
FGN	(Frame Ground)
SxD	(Send Data) - Data from the printer to the host.
RxD	(Receive Data) - Data from the host to the printer.
SGN	(Signal Ground)

Note: Depending on the host used, the CS and RS (maintaining at high) may need to be looped on the host side. Refer to host computer documentation for details.

CABLE REQUIREMENTS				
DB9	HOST	DIRECTION	DB25	PRINTER
3	Send Data	To Printer	3	Receive Data
2	Receive Data	To Host	2	Send Data
5	Frame Ground	Bi-Directional	7	Frame Ground

RECEIVE BUFFER CONTROL	
Causes For Receive Buffer Near Full	Occurs when the remaining free space of the buffer drops to 0.95MB of 2.95MB capacity or when the remaining free space is available for storing 50 of 500 items in the history buffer.
Release Of Receive Buffer Near Full	Can be released when the remaining free space rises to 1.95MB or when the remaining free space is available for storing 200 items in the history buffer.

STATUS5 TIMING CHARTS

NORMAL PROCESS

(Figure 3-8a)

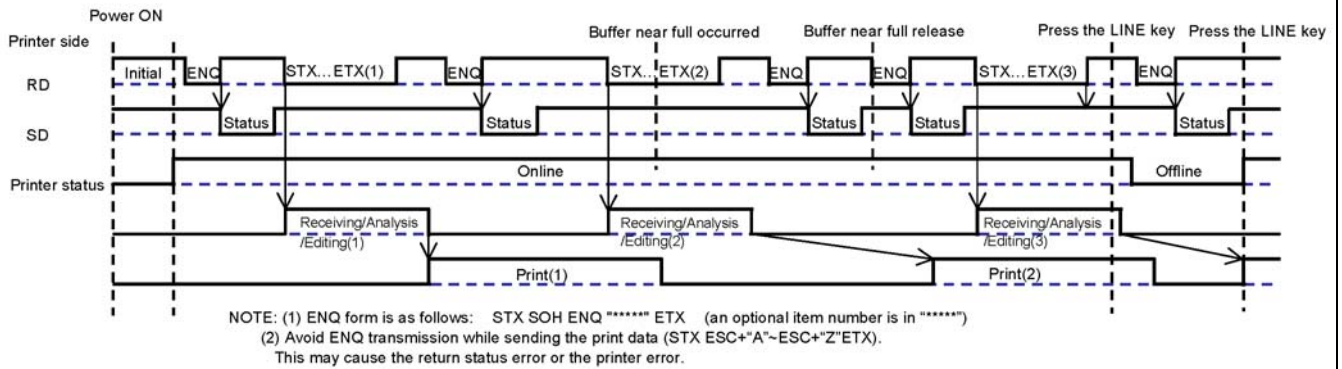

CANCEL PROCESS

(Figure 3-8b)

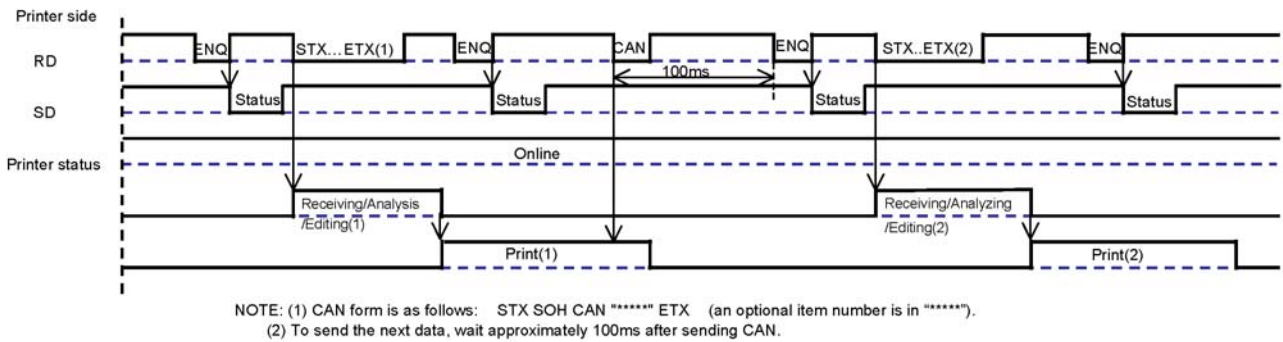

ERROR PROCESS

(Figure 3-8c)

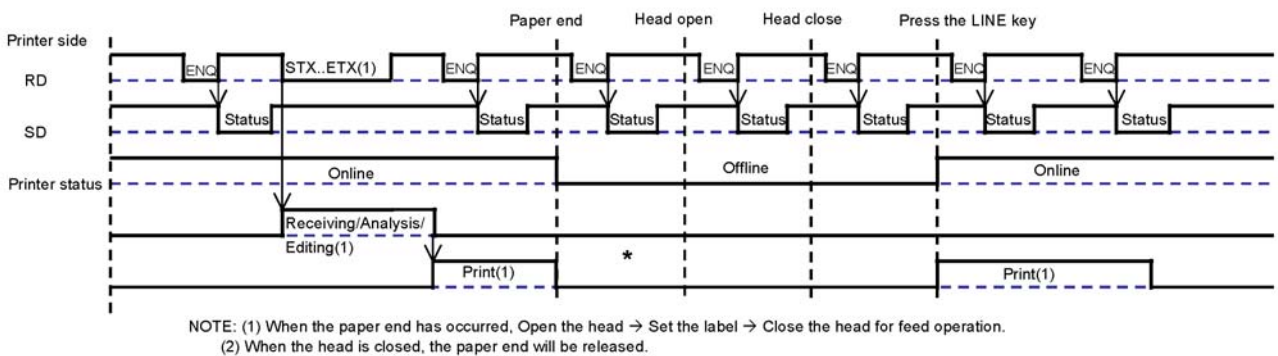

STATUS5 TIMING CHARTS

PRINT PROCESS

(Figure 3-8d)

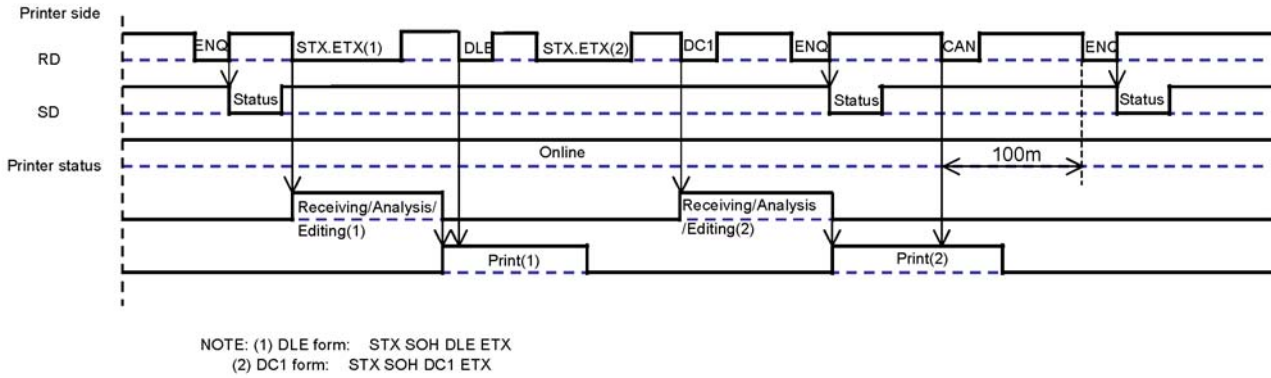

COMMAND PROCESS

(Figure 3-8e)

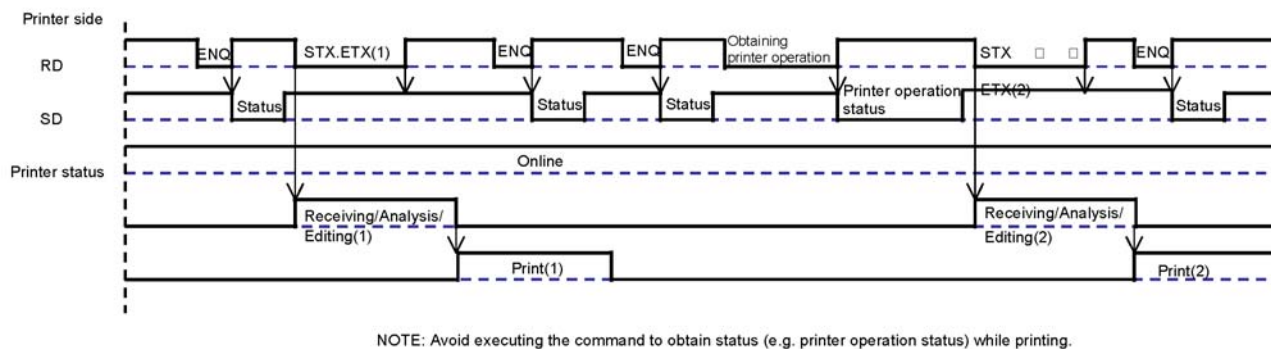

BCC ERROR PROCESS

(Figure 3-8f)

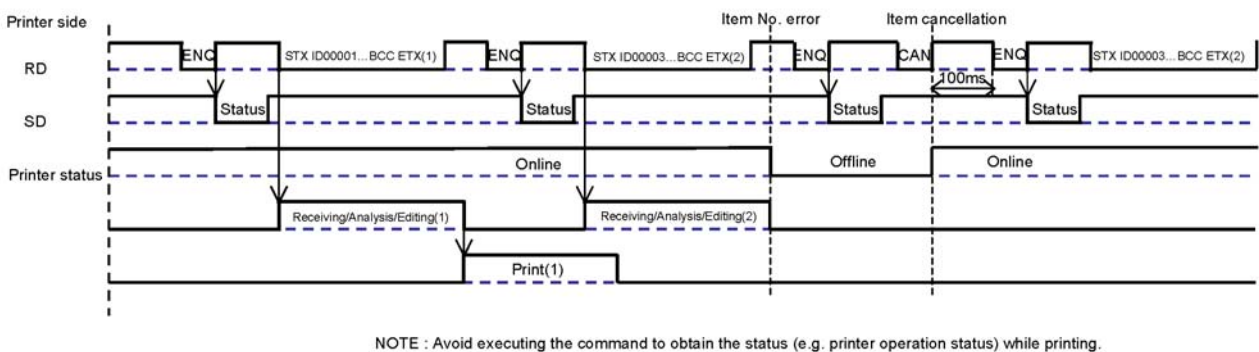

Unit 2: Technical Data

This page is intentionally left blank.

3

INSTALLATION

- **Unpacking & Parts Identification**
- **Printer Installation**
- **Operational Mode Selection**
- **Interface Selection**
- **Accessories Installation**

OVERVIEW

This section assists you in unpacking the printer from the shipping container. You will also be guided through a familiarization tour of the main parts and controls. The following information is provided herein:

- **Safety Precautions**
- **Unpacking and Parts Identification**
- **Loading Media**
- **Adjusting the Sensor**

SAFETY PRECAUTIONS

Please read the following information carefully before installing and using the printer

THE CAUTION SYMBOL

Whenever the triangular Caution logo appears in this manual, pay special attention to the warning(s) cited below it. Failure to abide by the warnings may result in injury or damage to property.

PRINTER PLACEMENT TIPS

- | | |
|--|---|
| <ul style="list-style-type: none"> • Place the printer on a solid, stable, horizontal surface that is not subject to strong vibrations from adjacent mechanical devices. • Avoid shaky or slanting tables, or platforms that are liable to collapse under a heavy weight. If the printer is dropped or damaged, immediately turn off the power, pull out the power plug and contact a service center. In this case, continued use of the printer may cause a fire or electric shocks. • Avoid installing the printer in direct sunlight, or in dusty, very hot or slippery areas. Also avoid placement in damp, unventilated or humid areas. If condensation forms, immediately turn off the power, and do not use the printer until the condensation disappears. Otherwise the moisture may cause electric shocks. • Avoid placing the printer near large high-current equipment, as such equipment can cause spikes or under-voltages in the power supply. | <ul style="list-style-type: none"> • Do not leave containers of water or chemicals around the printer. If any liquid is spilled onto the printer, immediately turn off the power, pull out the power cable from the AC outlet, and contact a sales outlet, dealer, or service center. In this case, continued use of the printer may cause fires or electric shocks. • Do not move the printer with any paper loaded. The stack of paper may fall off, causing trips and accidents. • When laying the printer down, be careful not to catch your foot or fingers under it. • When moving the printer, be sure to pull out the power cable from the AC outlet, and check that any other external interface cables have been disconnected. Otherwise, the connected cables may be damaged, or may cause trips and falls, in addition to or a fire or electric shocks. |
|--|---|

ELECTRICAL PRECAUTIONS

- | | |
|---|--|
| <ul style="list-style-type: none"> • When using head cleaning liquid, note that it is flammable. Never heat it or throw it into a fire. Keep it out of children's reach to avoid accidental consumption. Should this occur, consult a doctor immediately. • When opening/closing the cover, beware of getting your fingers caught. Also, hold the opening/closing cover well so that it will not slip and fall onto the hand. • After printing, the print head remains hot. When replacing paper or cleaning the printer immediately after printing, be careful not to burn yourself. • Touching even the edge of the printer head may cause injuries. When replacing paper or cleaning the printer, be careful not to hurt yourself. • If the printer will not be used for extended periods of time, disconnect the power cable for safety. • When releasing and locking down the printer head, be careful not to catch any other foreign matter in it except label paper. | <ul style="list-style-type: none"> • Do not disassemble or perform modifications to the printer, as this renders the product unsafe. For maintenance, troubleshooting and repairs, consult a sales outlet, dealer, or service center for help, instead of attempting to perform this yourself. Renewable annual service contracts are available. • When maintaining or cleaning the printer, always disconnect the power cable for safety. • Do not insert your hand or other objects into the cutter. • When loading roll paper, be careful not to catch your fingers between the paper and the feeder. • Be careful not to hurt yourself when detaching the back cover of the fanfold through the hole and attaching it. • The simplified cutter (if applicable to the printer) is structured as a blade. Be careful to avoid injury when operating the printer. |
|---|--|

GENERAL PRECAUTIONS	
<ul style="list-style-type: none">• When using head cleaning liquid, note that it is flammable. Never heat it or throw it into a fire. Keep it out of children's reach to avoid accidental consumption. Should this occur, consult a doctor immediately.• When opening/closing the cover, beware of getting your fingers caught. Also, hold the opening/closing cover well so that it will not slip and fall onto the hand.• After printing, the print head remains hot. When replacing paper or cleaning the printer immediately after printing, be careful not to burn yourself.• Touching even the edge of the printer head may cause injuries. When replacing paper or cleaning the printer, be careful not to hurt yourself.• If the printer will not be used for extended periods of time, disconnect the power cable for safety.• When releasing and locking down the printer head, be careful not to catch any other foreign matter in it except label paper.	<ul style="list-style-type: none">• Do not disassemble or perform modifications to the printer, as this renders the product unsafe. For maintenance, troubleshooting and repairs, consult a sales outlet, dealer, or service center for help, instead of attempting to perform this yourself. Renewable annual service contracts are available.• When maintaining or cleaning the printer, always disconnect the power cable for safety.• Do not insert your hand or other objects into the cutter.• When loading roll paper, be careful not to catch your fingers between the paper and the feeder.• Be careful not to hurt yourself when detaching the back cover of the fanfold through the hole and attaching it.• The simplified cutter (if applicable to the printer) is structured as a blade. Be careful not to cut yourself.

This is a piece of Class B information technology equipment based on the standards of the Voluntary Control Council for Interference by Information Technology Equipment (VCCI). Although this equipment is for use in home environment, if it is used close to a radio or television set, it may cause poor reception. Handle it properly in accordance with the content from the instruction manual.

UNPACKING & PARTS IDENTIFICATION

When unpacking the printer, take note of the following:

<p>1 The box should stay right-side up. Lift the printer out of the box carefully.</p>	<p>4 If the printer has been stored in the cold, allow it to reach room temperature before turning it on.</p>
<p>2 Remove the plastic covering from the printer.</p>	<p>5 Set the printer on a solid, flat surface. Inspect the shipping container and printer for any sign of damage that may have occurred during shipping.</p>
<p>3 Remove the accessory items from their protective containers.</p>	

Note:

The following parts shown here are representative only. Due to regional requirements and our policy of continual improvement, your printer may not be packed with the exact parts as shown here, but the unpacking steps are similar.



CT4i Printer



User documentation and software package (where applicable)

Figure 3-1, Unpacking & Parts Identification

PRINTER INSTALLATION

This chapter provides guidance on how to station, connect, and load the printer once unpacked. Following printer setup, proceed to the next chapter for information on interface selection.

SITE LOCATION

- Station the printer on a solid flat surface.
- Station it away from hazardous materials or dusty environments.
- Station it within operational distance of the host computer, within interface cable specifications

MEDIA SELECTION

The size and type of the labels or tags to be printed should have been taken into consideration before printer purchase. Ideally, the media width will be equal to, or just narrower than, the print head. Using media that does not cover the print head will allow the platen roller to tread on it and wear it out. The media edge will also wear a groove in the platen roller affecting print quality.

MEDIA LOADING: ROLLED PAPER

There are two general label types that may be loaded and used; **rolled** and **fan-folded**. Each of those types may again be defined by whether their print application is **direct thermal** or **thermal transfer**. Those factors determine how the media is loaded and if ribbon stock is loaded at all.

Thermal transfer media requires the use of ribbon stock for print application. In such a scenario, it is the ribbon stock (carbon paper) that contains the ink that will be transferred to the media. **Direct thermal** media has a coating on the surface that is made visible through the application of heat from the print head. **Rolled media** of standard diameter is loaded within the printer and suspended by the media holder.



1 Get the media ready.

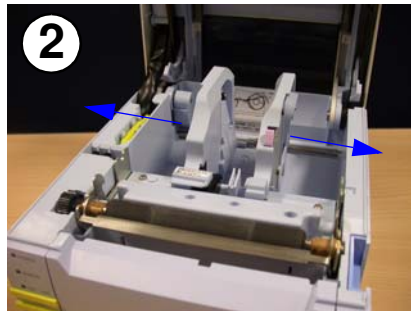

2 Press the label guide release knob and pull the guides apart.

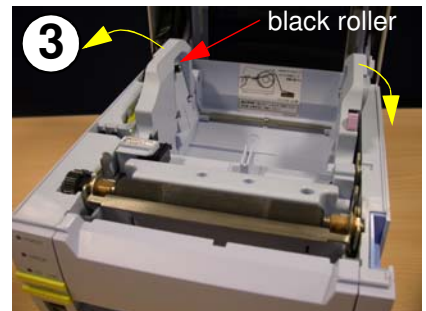

3 Push the left label guides's tab outwards before loading labels.

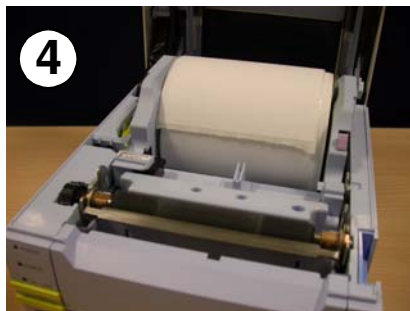

4 Load the label roll. Its core should rotate freely over the black rollers.

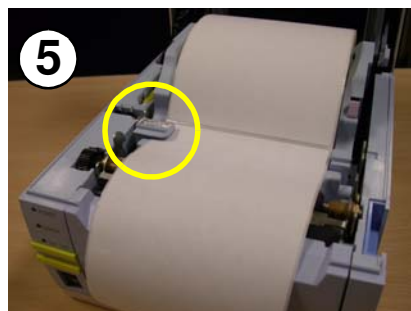

5 Pull the paper under the label sensor, out to the front of the printer.



6 Close the cover. Direct thermal printing is now possible.

Figure 3-3a, Rolled Label Loading

RIBBON LOADING

This chapter provides guidance on how to station, connect, and load the printer once unpacked. Following printer setup, proceed to the next chapter for information on interface selection.



1 Get the media ready. The label roll is optional in this procedure.



2 Raise the ribbon loader assembly as shown here.

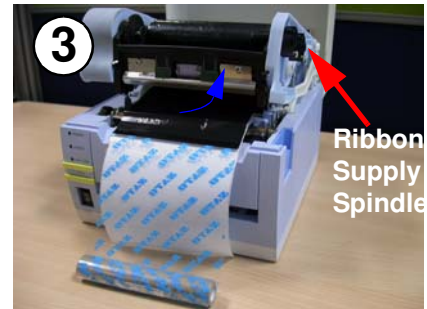

3 Load the ribbon roll (shiny side up) into the supply spindle from underneath (see blue arrow). **Ribbon Supply Spindle**

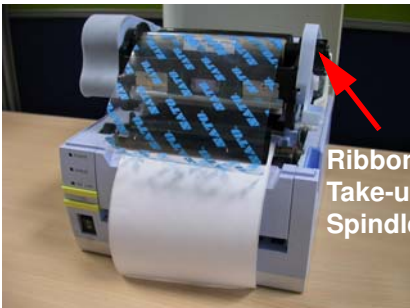

Load the ribbon core into the take-up spindle. **Ribbon Take-up Spindle**



Turn the the take-up spindle to reduce any slack in the ribbon.

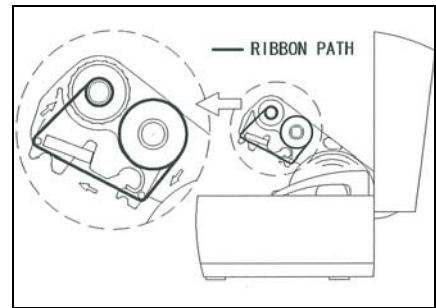

Ribbon loading is now complete. The loading path is as depicted.

Figure 3-3b, Ribbon Loading

NOTES

- For best printing results and minimal operational problems, use only genuine SATO-approved combinations of ribbon and labels.
- Beware of injury when lifting or closing the printer covers.
- Remove the label and ribbon media before transporting the printer.
- For ribbon widths of 76 mm/59 mm/45 mm, insert the supplied Core Adapter into the core of the ribbon roll before loading it into the printer.
- The ribbon loading assembly can be stowed away inside the top cover and held in place by the black plastic latching mechanism (see “general description” on page 1-3)
- Do extended test prints of specific combinations of ribbon and label media before purchasing them for volume usage.
- If an optional cutter is installed, be sure to keep your hands away from the cutter blade when attempting to load or adjust media.

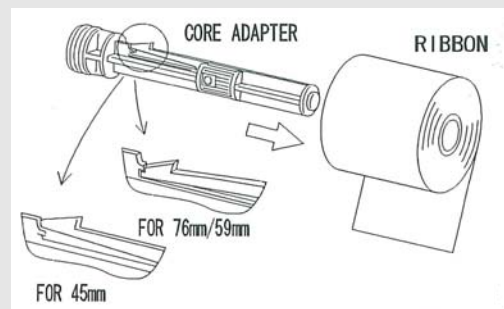

LOADING FANFOLD PAPER

Fan-folded media is fed inward from the rear, via the rear housing cover (highlighted in yellow below), but is stacked as opposed to suspended. Ribbon can be wound in or wound out.

1. Place the fanfold media behind the printer with the printing surface up.
2. Carefully pull up the Fanfold-label Loading Slot from the back of the Top Cover.
3. Open the Top Cover by pressing on the cover release latch located on the right-hand side of the printer. This releases the cover and allows it to swing upward on the rear-mounted hinges.
4. With the Top Cover in the upright position, press the Paper Guide Release while adjusting the Paper Guides until they allow the media to fit between them. A millimeter scale is molded into the case to provide a guide when making the adjustment. The Paper Guides are center-justified and interact with each other so that each moves an equal distance apart from each other.
5. Route the label material through the Sensor Assembly and over the Platen. See figure 3-4 for the label route.
6. Close the Top Cover.
7. After loading the label media, it is recommended that you run a Test Print to make sure the labels are correctly loaded and printed.

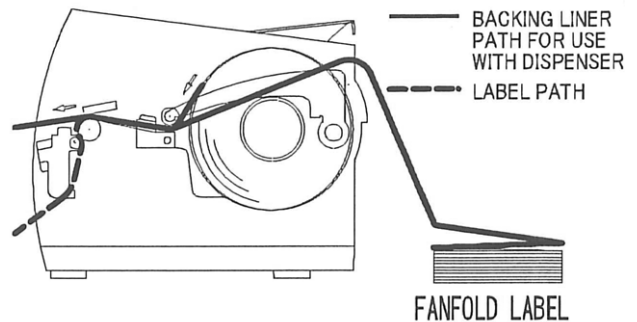
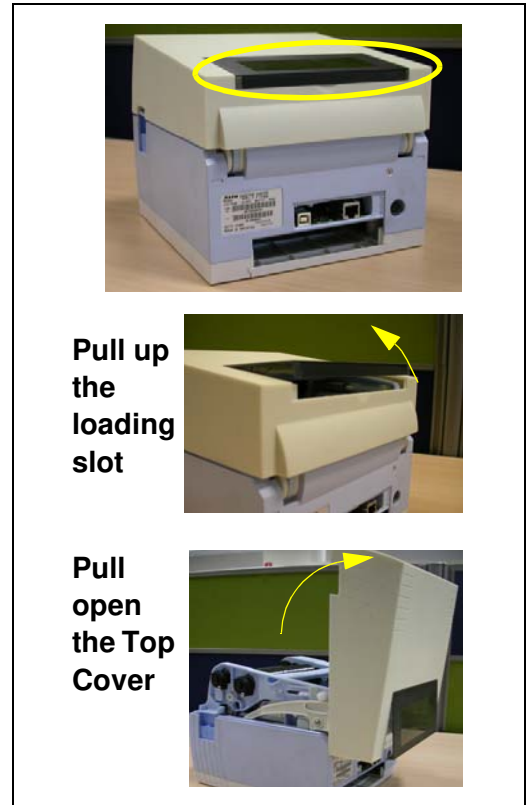

Overview of the fanfold-paper loading path

Figure 3-4, Fanfold paper loading

LABEL SENSING

The SATO CT4i uses label Gap (see-thru) as well as I-Mark sensing. The Sensor Assembly is located on the left edge of the media and is automatically positioned by the Paper Guides.

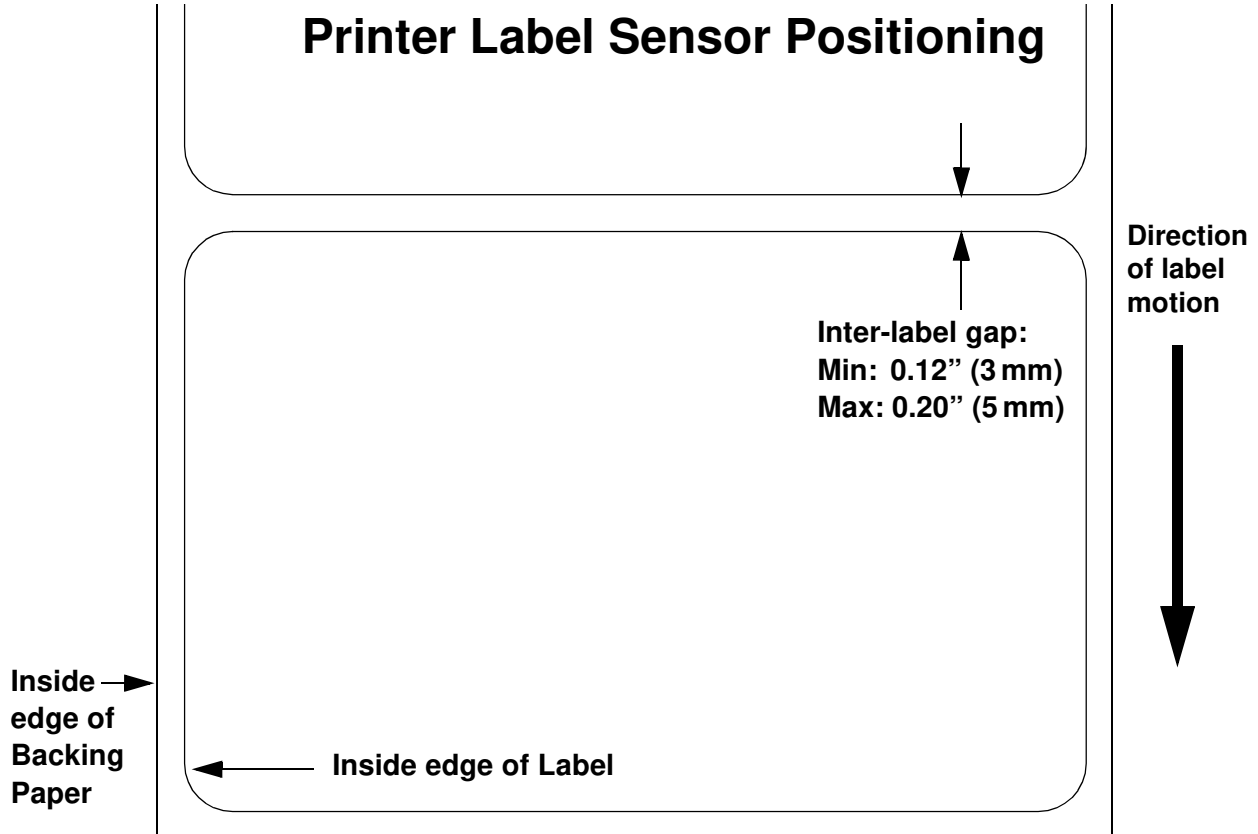

OPERATIONAL MODE SELECTION

There are two modes of printer operation; Dispense and Continuous. The difference between the two is the way that the label and paper backing is ejected. Before printer configuration, one must determine which mode will be used. This chapter identifies the functional differences between the two.

ATTENTION: Refer to the Printer Configuration unit of this manual to program the printer's internal memory to suit individual needs using the integrated menu options. Refer to the Programming Reference document to remotely program the printer's features and functions through a host system.

CONTINUOUS MODE

With this mode of operation, the media remains in position for printing at all times. To do so, means that the previous printed label is only available for removal when one to four additional labels have been printed (quantity is depended on label size). This mode of operation is specifically suited for printing bulk quantities to be applied later.

TEAR-OFF MODE

With this method of operation, after printing, the printer feeds the first (outermost) label so that it is fully extended out of the printer's front for removal. Printing of the next label will not begin until the prior printed label has been removed. This mode of operation is specifically suited for immediate application at the time of print.

Upon removal of the prior printed label, the printer retracts the media so that the next label in line may be printed, then prints. This cycle, repeats for each consecutive label.

CUTTER MODE

With the cutter assembly installed and enabled, this mode of operation will cut individual printed labels or in multiples. The media will be advanced to the cutter blade, the label cut will occur, and the unprinted media will retract for positioning of the next print.

DISPENSE MODE

When the dispenser assembly is installed and enabled, this mode of operation will peel the paper backing from the printed label as it is advanced to the printer's front. Once the printed label has been removed from the printer for application, the unprinted media will retract and position itself so the next label may be printed.

This operational mode is specifically applicable to print operations where the label is to be immediately adhered.

LINERLESS MODE

When the linerless option is installed and enabled, this mode of operation allows for the feeding and printing of linerless media. In this mode, the printer's functionality is the same as with the continuous or tear-off modes - depending on configuration settings.

Unit 3: Installation

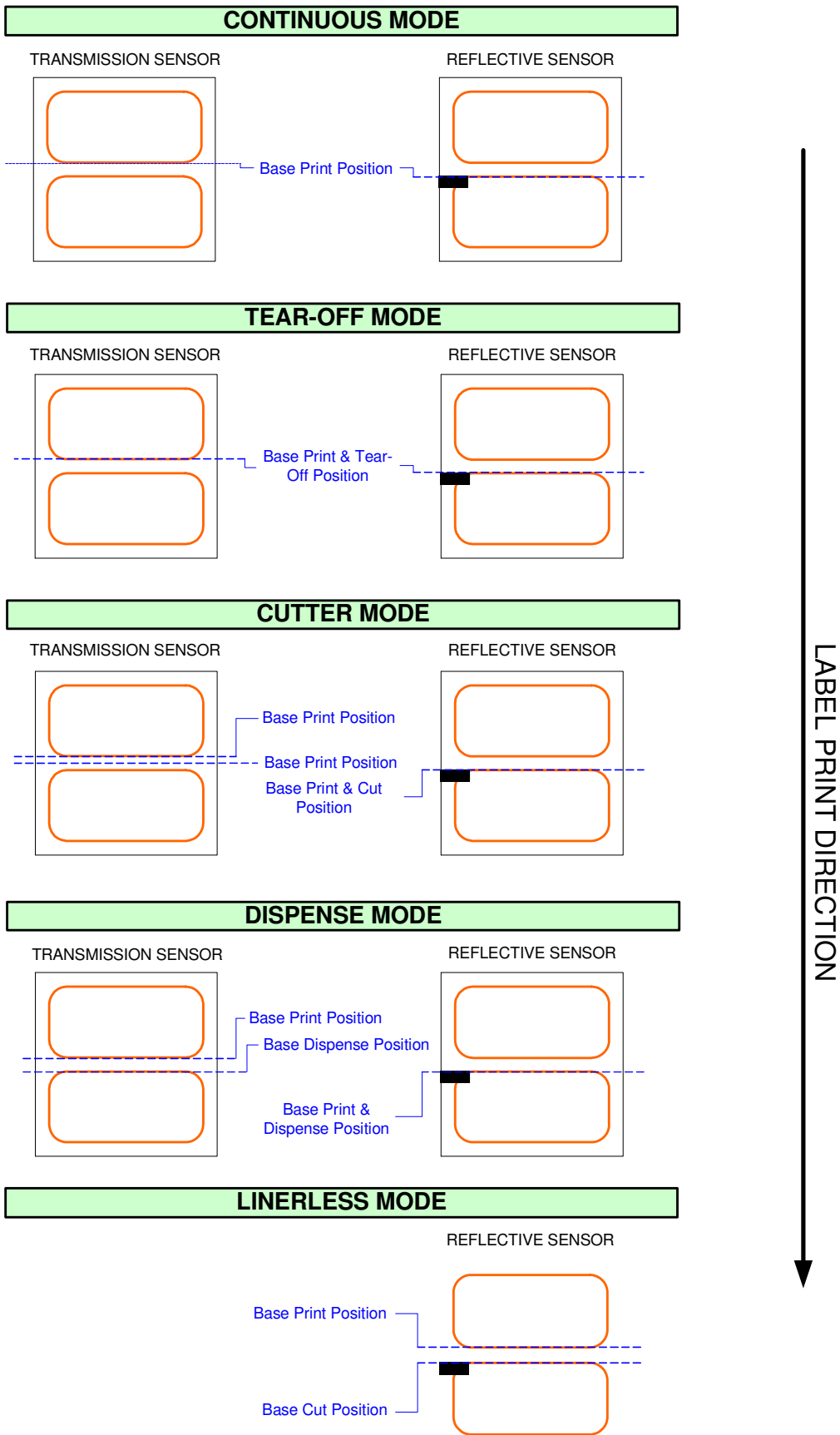

Figure 3-4, Label Reference Position

Unit 3: Installation

This page is intentionally left blank.

4

PRINTER CONFIGURATION

- Configuration Modes
- Configuration Modes
- Menu Definition Tables

CONFIGURATION MODES

Before using the printer, it is best to read this manual thoroughly first. Otherwise, you may disturb default settings around which the instructional procedures in this manual are based upon. The printer may be configured via the buttons and/or potentiometers located on the printer's front panel. All of the printer's buttons, switches, and potentiometers are used either singularly, or in conjunction, to perform configuration activities.

4.1 OPERATING PANEL

The Operator Panel consists of three LED indicators and three switches.

POWER

The green LED lights up when the printer is ON.

ERROR

The red LED lights up when there is a system fault such as an unlatched print head.

ON LINE

The green LED lights up when the printer is ON LINE and ready to receive data. The ON LINE button takes the printer ON LINE or OFF LINE.

ON LINE Button

If the ONLINE LED is lit, pressing it will take the printer OFF LINE. Pressing the button again then takes the printer back ON LINE. When ON LINE, the printer is ready to receive data from the host. When OFF LINE, the printer will not print or accept data from the host. While the printer is printing, press this button to suspend the printing. To resume printing, press this button again.

FEED BUTTON

Press this button to eject one label in OFF LINE mode. Hold this button down while power is applied, to print a printer status label.

POWER SWITCH

A two position switch for turning the printer ON (I) or OFF (O).



4.2 THE REAR PANEL

All of the printer cable connectors are located on the Rear Panel, as follows.

Fanfold-label Loading Slot

Remove this panel to route fanfold paper into the printer



Optional interface slot

This slot can be used to house an additional optional interface card to supply a parallel, bluetooth or WLAN interface connection.

Factory installed USB + RS232C Interface

This interface can be selected at the time of purchase. You can also select USB + LAN interface as the factory installed interface.

4.3 THE CONFIGURATION PANEL

The Configuration Panel is accessible when you lift up the top cover.

The panel consists of an eight-position DIP switch, three adjustment potentiometers and a seven-segment LED Error Status display. Receptacles for connecting the optional Cutter (factory installed) are also located on this panel.

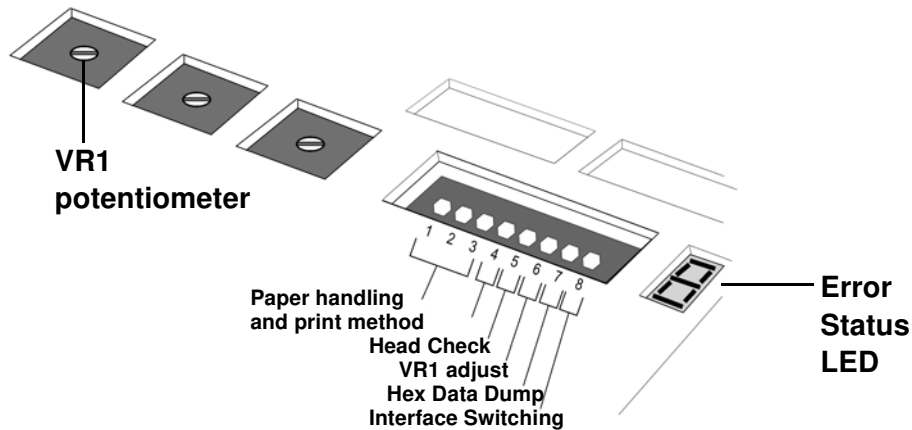

DIP SWITCH SETTINGS

This is an eight-position switch used for setting the operating conditions of the printer. Switches 1 to 3 act as control for both paper handling and the loading of programs or fonts into the printer.

Switches 1–3: Paper Handling settings

These three switches select the method used for controlling paper handling:

Continuous mode - (default mode) Does not use the sensor for paper indexing. The paper movement will stop after all the label data has been printed.

Tear Off mode - Paper is fed out to the cut/tear off position after printing is complete. Before the next label is printed, the paper is pulled back in to the first print line position.

Cutter mode - Enables the Cutter option if installed.

Partial Cut Compatibility mode - If a partial-cutter (a cutter that can be set to cut labels partially so that they are not completely cut off the main label roll) is installed, use this mode for proper operation and control of the cutter.

DSW1	DSW2	DSW3	Mode
Off	Off	Off	Continuous
Off	Off	On	Linerless
On	Off	Off	Tear Off
Off	On	Off	Cutter
On	Off	On	Program Download Mode
Off	On	On	Font Download
On	On	On	Partial Cut Compat. Mode

Configuration Switch

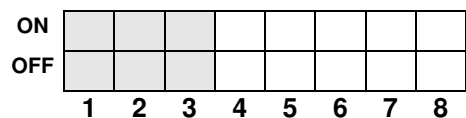

4.3 DIP SWITCH SETTINGS (CONT'D)

Switches 1–3: Font loading settings

Enables the loading of fonts and/or graphics into printer memory for faster retrieval.

DSW1	DSW2	DSW3	Mode
Off	On	On	Font Download

Configuration Switch

ON	<input checked="" type="checkbox"/>	<input checked="" type="checkbox"/>	<input checked="" type="checkbox"/>	<input type="checkbox"/>	<input type="checkbox"/>	<input type="checkbox"/>	<input type="checkbox"/>	<input type="checkbox"/>
OFF	<input type="checkbox"/>	<input type="checkbox"/>	<input type="checkbox"/>	<input type="checkbox"/>	<input type="checkbox"/>	<input type="checkbox"/>	<input type="checkbox"/>	<input type="checkbox"/>
	1	2	3	4	5	6	7	8

Switch 4: DT/TT Mode

Switches the printer between Direct Thermal (DT) or Thermal Transfer (TT).

DSW4	Mode
Off	DT
On	TT

Configuration Switch

ON	<input type="checkbox"/>	<input type="checkbox"/>	<input type="checkbox"/>	<input checked="" type="checkbox"/>	<input type="checkbox"/>	<input type="checkbox"/>	<input type="checkbox"/>	<input type="checkbox"/>
OFF	<input type="checkbox"/>	<input type="checkbox"/>	<input type="checkbox"/>	<input type="checkbox"/>	<input type="checkbox"/>	<input type="checkbox"/>	<input type="checkbox"/>	<input type="checkbox"/>
	1	2	3	4	5	6	7	8

Switch 5: Head Check On/Off

Enables or Disables the printer function that automatically checks the print head for open circuits. On detecting a head error along any part of the print head, the ERROR LED will be lit continuously. The printer will not allow any further operation unless the following buttons are press, or certain actions are taken.

- 1) Press the ONLINE and FEED buttons for five seconds. The ONLINE LED lights for a brief moment, and then the printer is taken OFFLINE. Restart the printer to continue printing as per normal.
- 2) The printer can be set to two types of Head Check Processes. The first check process is termed "Barcode", where only barcodes printed via the printer's built-in functions are checked to detect the presence of print element failure. The other check process is termed "Normal", wherein all printed areas (whether it is text or graphics or barcodes) will be checked to detect the presence of print head problems.

DSW5	Mode
Off	Disabled
On	Enabled

Configuration Switch

ON	<input type="checkbox"/>	<input type="checkbox"/>	<input type="checkbox"/>	<input type="checkbox"/>	<input checked="" type="checkbox"/>	<input type="checkbox"/>	<input type="checkbox"/>	<input type="checkbox"/>
OFF	<input type="checkbox"/>	<input type="checkbox"/>	<input type="checkbox"/>	<input type="checkbox"/>	<input type="checkbox"/>	<input type="checkbox"/>	<input type="checkbox"/>	<input type="checkbox"/>
	1	2	3	4	5	6	7	8

Unit 4: Printer Configuration

To switch between different Barcode or Normal Head Check modes, set DSW7 to ON (for Barcode checking) or OFF (for Normal checking) and then enter the Factory Clear Mode (Head-open + ONLINE + FEED + POWER ON). Follow the flow chart below for checking the print head.

**Select counter to be cleared with DSW 5 and DSW6 beforehand.
Select head check parameter with DSW7 (ON=Barcode, OFF=Normal)**

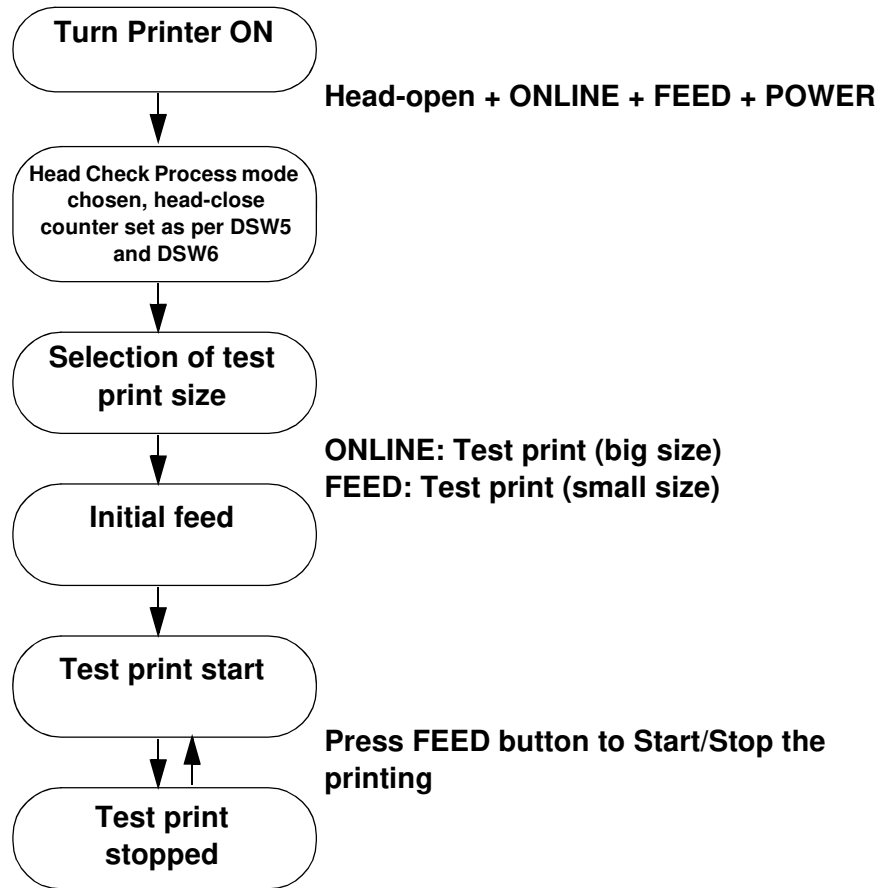

The test print label shows either one of the following messages for Normal checks:

HEAD CHECK(PRINT) OK
HEAD CHECK(PRINT) NG

The test print label shows either one of the following messages for Barcode checks:

HEAD CHECK(BARCODE) OK
HEAD CHECK(BARCODE) NG

Note that the Barcode head check only applies to barcodes printed via the ESC+B, ESC+D, ESC_BD commands. The head check is not effective in cases where barcodes are created as graphics. In previous models, the the head check parameter can be only adjusted when clear counter ALL was selected. The CT4i series does not have this restriction, and the head check parameter is independent of the clear counter ALL setting.

Switch 6: VR1 Potentiometer Adjustment mode

Selects the function adjusted by VR1. If DSW6 is Off, VR1 adjusts the pitch offset value over a range of +/- 3.75 mm. When DSW6 is On, VR1 adjusts the print darkness range.

DSW6	Mode
Off	Pitch Offset
On	Print Darkness

Configuration Switch

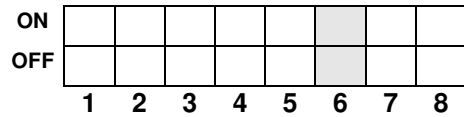

Switch 7: Hex DATA Dump

When ON, the printer will print out the hex value for each character received. When OFF, the printer will accept and process the data stream in a normal fashion.

DSW7	Mode
Off	DISABLED
On	ENABLED

Configuration Switch

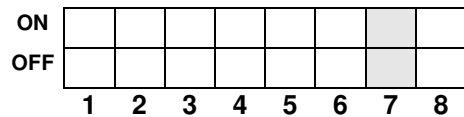

Switch 8: Interface Board Switching

This switch lets you choose whether to use the factory installed interface board connectors, or the user-installable Extended Interface board.

If no extended interface board is detected, switching DSW8 to Off will not affect the use of the built-in interface.

DSW8	Mode
Off	Use extended interface
On	Use internal interface

Configuration Switch

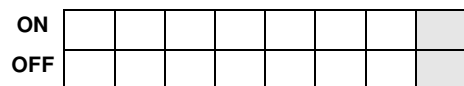

4.4 OPERATIONAL MODES

The CT4i operates in 10 different modes, where each mode can be invoked via combinations of pressing the front panel buttons in a certain sequence together with DIP switch settings and print head status. The table below lists all the modes and how they can be invoked.

Table 1: Power ON sequence for various Operational Modes

Mode #	ONLINE BUTTON	FEED BUTTON	PRINT HEAD STATUS	DSW SETTING	Operational Mode
1					Normal Operational Mode
2		Press			User Test Print Mode
3	Press	Press			Default Setting Mode
4	Press	Press	Head Open		Factory Clear Mode
5				DSW7=ON	HEX Dump Mode
6				DSW1=On DSW2=Off DSW3=On	Program Download Mode
7				DSW1=Off DSW2=On DSW3=On	Font Download Mode
8	Press	Press	Head Open	DSW7=On	Head Check Mode
9	Press	Press		DSW1~8=On	Boot Download Mode
10				DSW1=On DSW2=On DSW3=On	Partial Cut Compatibility Mode

4.4 OPERATIONAL MODES (CONT'D)

Following are the standard operational functions and procedures available for selected modes. Modes not covered here are covered in the Service Manual.

4.4.1 Normal Mode

The printer normally starts up in this mode. It automatically goes ONLINE and is ready for printing jobs. The following operations are possible:





- Pressing the ONLINE button repeated takes the printer to ONLINE or OFFLINE mode alternately.
- During a print job, pressing the ONLINE button will pause the job. Press the ONLINE button again to resume the job.
- Pressing the FEED button in OFFLINE mode will advance a blank label if the label sensor is enabled.
- Pressing the FEED button in OFFLINE mode if the label sensor is disabled, results in the paper size not being verified and the paper is fed in as long as the FEED button is held down. The feed procedure is stopped as soon as the FEED button is released. Also, for concurrent cutter/liner-less operation, the paper cutting is executed as soon as the feed is halted (the feed button is released). A back-feed may be performed after the cut has been executed.
- Taking the printer OFFLINE and pressing the ONLINE and FEED buttons will disable response to any JOB-CANCEL command from the host computer. Then press the FEED button to return to OFFLINE mode. The LED shows 
- Taking the printer OFFLINE and pressing the ONLINE and FEED buttons will disable response to any JOB-CANCEL command from the host computer. To enable the JOB-CANCEL command, press the ONLINE button followed by the FEED button. The printer will return to OFFLINE mode. The LED shows 

Table 2: LED and Buzzer status during Normal Mode operation

Function	ONLINE LED	ERROR LED	BUZZER
Normal printing operation	ON	OFF	1 beep
Online	ON	OFF	-
Offline	OFF	OFF	-
Job-cancel command switch-over to select Disable	OFF	OFF	1 beep
Sets Job-cancel command to Disable	OFF	OFF	-
Sets Job-cancel command to Enable	OFF	OFF	-
Switch-over from Job-cancel command (Sets to Enable or Disable) to offline state	OFF	OFF	1 beep
Switch-over from enabled Job-cancel command to preferred interface selection	OFF	OFF	1 beep
USB interface preferred	OFF	OFF	-
Other interfaces preferred	OFF	OFF	-
Switch-over to offline after having selected preferred interface	OFF	OFF	1 beep

- After a print job is cancelled, the printer will switch to a preferred interface, granting priority to the USB interface, but otherwise switching to the next available interface. The automatically selected interface will be indicated on the LED. Press the ONLINE button to choose another available interface instead. Or press the FEED button to confirm the automatically selected interface. The LED shows  for USB interface selection, or  for other interfaces

4.4.2 User Test Print Mode (FEED + POWER ON)

This mode produces test labels for diagnostic purposes. Upon entering this mode on startup, release the FEED button. A beep is then produced, and the ERROR LED will light up.

When labels have been loaded properly, press the ONLINE or FEED button to start printing. Pressing the FEED button produces small test label data, while the ONLINE button produces a big test print.

The ERROR LED goes off during the test printing. Pressing the FEED button at any time during the test print operation will pause or resume the print job.

Note: To end the test print, make sure to press the FEED button to pause the printing, then turn the printer OFF.

The following data will be produced on the test print:

Table 3: Data found on Test Prints

No.	Data Printed
1	Base reference point offset (Vertical, horizontal)
2	Pitch offset
3	Cut position offset
4	Dispensing position offset
5	Tear off position offset
6	Label size (Pitch, width)
7	Print speed
8	Print darkness
9	Sensor type
10	Kanji character code
11	Paper end detection method
12	Zero slash
13	Proportional pitch
14	Buzzer
15	Initial feed
16	Interface settings Type, buffer control, protocol, communication settings
17	Dip switch input/output function
18	Protocol code setting value
19	Euro-code (CT Series)

For a picture of the print sample, refer to “test label printing” on page 5-8.

4.4.3 Default Settings Mode (ONLINE + FEED + POWER ON)

Turning the printer ON in this mode simply resets major settings to their default values. (See table). After the default values have been restored, the printer emits three beeps. The ERROR LED also lights up during the reset operation, but goes off after the settings have been activated.

Parameter	Default Setting
Reference position	Vertical: 0dot, Horizontal: 0dot
Pitch offset	0 dot
Cut position offset	0 dot
Dispensing position offset	0 dot
Tear off position offset	0 dot
Label size (Pitch, width)	Pitch=3200 dot x width 832dot [8dots/mm] Pitch=4800 dot x width 1248dot [12dots/mm] Pitch=9600 dot x width 2496dot [23.6 dots/mm]
Print speed	100 mm/s [8dots/mm] [12dots/mm] 50 mm/s [23.6dots/mm]
Print darkness	3A [Direct thermal] 3B [Thermal transfer]
Sensor type	Gap
Kanji character code	JIS
Paper end detection means	Roll type
Zero slash	Enable
Proportional pitch	Enable [CT Series]
Buzzer	Enable
Initial feed	Disable
Auto-feed	Disable
Gap size	24dots [8dots/mm] 36dots [12dots/mm] 72dots [23.6dots/mm]
Optional operation modes	Operation No. 1
VR (Potentiometer)	Option stop position offset =0, print darkness=0
Interface settings	IEEE1284: Multi buffer, ACK width =500ns RS-232C: Baud rate=19200bps, Data-bit=8bit, Parity=off, Stop bit=1bit, Control=READY/BUSY control (multi- buffer) LAN/Wireless LAN: Driver exclusive protocol (Status 4) cycle response mode (2-port connection using Port 1024 and Port 1025, or 1 port connection using Port 9100.) USB: (no default settings) Bluetooth: Bluetooth mode = Status 4, PIN code = 0000000000000000, Authentication mode = Authentication Level 1, ISI=0800, ISW=0012, PSI=0800, PSW=0012, Device name = SATO ONLINE PRINTER, CRC Check = Disable

4.4.4 HEX Dump Mode (POWER ON with DSW7=ON)

When turned ON in this mode, the printer will print a dump of its buffer contents received for the host. The printer awaits data feeds and when data arrives, it prints out the HEX data continuously.

To terminate the HEX Dump, set DSW7 to OFF and restart the printer.

4.4.5 Factory Clear Mode (Print head left open + ONLINE + FEED + POWER ON)

When turned ON in this mode, the printer clears various counters and settings, then generates printouts for the user's reference.

Three DIP Switches (DSW5, DSW6, DSW8) can be set in various configurations to determine which settings are reset.

DSW5	DSW6	DSW8	Settings Affected
OFF	OFF	-	No reset
OFF	ON	-	Cutter counter reset
ON	OFF	-	Head counter reset
ON	ON	-	
ON	ON	OFF	All-clear (Cutter, head, factory counter, printer settings) *applicable to CT408iDT / CT412iDT / CT424iDT only
ON	ON	ON	All-clear (Cutter, head, factory counter, printer settings) *applicable to CT408iTT / CT412iTT / CT424iTT only]

The following operations are possible:

- Once the printer has been started in this mode, latch the print head to clear all affected counters.
- Next, select the test print size by pressing ONLINE (big size) or FEED (small size).
- The printer issues a label feed, and then starts printing once the factory settings have been applied. The ONLINE LED turns OFF while the printer is waiting to print. The ERROR LED turns ON once, during the start of the factory clear mode, but is otherwise OFF.
- Pressing the FEED button each time will pause or resume the printing.
- To terminate the test printing, pause the printing and turn the printer OFF.
- The setting of DSW7 can affect the print head check result.

4.4.6 Program Download Mode (DSW1=ON, DSW2=OFF, DSW3=ON + POWER ON)

In this mode, the printer is set to receive an application program from the host computer to download into its memory. Remember to set the printer to the correct active interface to be used for the data transfer. The status of various indicators in this mode is summarized below:

Function	ONLINE	ERROR	BUZZER	LED Display
During download mode	ON	OFF	1 beep	1
Wait to receive data	ON	OFF	-	1
During data transfer (start of data transfer)	ON	OFF	1 beep	2
Data editing	ON	OFF	-	3
Flash ROM clear	ON	OFF	-	4
Writing to Flash ROM	ON	OFF	-	5
Download completed	ON	OFF	3 long beeps	1
Download error	Blinking	Blinking	1 long beep	F

- To exit this mode, make sure the printer is waiting to receive data (ONLINE LED=ON, ERROR LED=OFF, LED Displays “1”, No Buzzer beep) and not performing any data transfer.
- Restart the printer after completion of the download, and perform a factory test print.

4.4.7 Font Download Mode (DSW1=OFF, DSW2=ON, DSW3=ON + POWER ON)

In this mode, the printer is set to download fonts from the host computer. Remember to set the printer to the correct active interface to be used for the data transfer. The status of various indicators in this mode is summarized below:

Function	ONLINE	ERROR	BUZZER	LED Display
During download mode	ON	OFF	1 beep	1
Wait to receive data	ON	OFF	-	1
During data transfer (start of data transfer)	ON	OFF	1 beep	2
Writing font data	ON	OFF	-	3
Writing font information	ON	OFF	-	4
Download completed	ON	OFF	1 beep	5
Download error	ON	ON	3 beeps	F

- To exit this mode, make sure the printer is waiting to receive data (ONLINE LED=ON, ERROR LED=OFF, LED Displays “1”, No Buzzer beep) and not performing any data transfer.

4.4.8 Errors during Font and Program Download Modes

- Possible causes of errors could be that the data transfer is not correct between the printer and host, due to interface setting incompatibilities or faults in the cable.

The flash ROM may be in a state that does not permit data being written to it. The following error diagnostics are useful to help you troubleshoot the actual cause(s):

Cause	ONLINE	ERROR	BUZZER	LED Display
Flash ROM Error	OFF	ON	1 long beep	O
Error during data download	OFF	OFF	1 long beep	F
Error during font download	ON	ON	3 short beeps	F

CAUTION

- Make sure that you do NOT turn the printer OFF when data is transferring to the flash ROM in Program or Boot Download mode, as it may corrupt the firmware and prevent the printer from starting up correctly.
- Ensure that the printer is running on a stable power supply during such flash ROM writing operations.

4.4.9 Boot Download Mode (DSW1-8=ON + ONLINE + FEED + POWER ON)

This is a critical mode meant only to be handled by experienced operators. Avoid using this mode if you are not clear about its function.

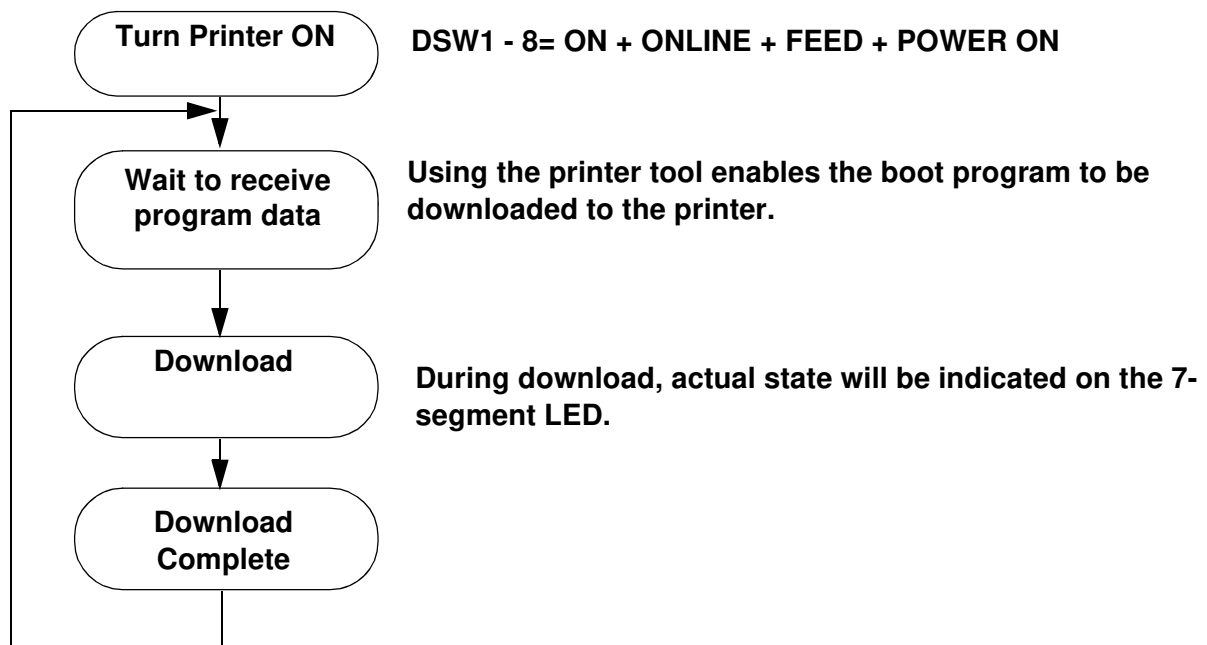

Unit 4: Printer Configuration

During the process, the following LED and Buzzer states may be observed:

Function	ONLINE	ERROR	BUZZER	LED Display
During download mode	ON	OFF	1 beep	1
Wait to receive data	ON	OFF	-	1
During data transfer (start of data transfer)	ON	OFF	1 beep	2
Data Editing	ON	OFF	-	3
FLASH ROM Clear	ON	OFF	-	4
Writing to FLASH ROM	ON	OFF	-	5
Download completed	ON	OFF	3 long beeps	1
Download error	Blinks	Blinks	1 long beep	F

Notes:

- Connection to the host computer will be established via the active interface (standard/extended).
- First bring the printer into "Waiting for boot data transfer mode" before downloading.
- Downloaded application program will be enabled at the next power on after executing factory clear (All clear).
- To exit font download mode, make sure that it is in "Waiting to receive data" mode before turning the power off.
- Confirm that the download has terminated successfully, by checking the monitor of the printer tool, and by checking the post-download printer program information.
- Check the system version of printer, performing a factory test print.

4.4.9 Partial Cut Compatibility Mode (DSW1-3=ON)

For further details refer to Page 4-4..

4.4.10 Head Check (DSW5 and DSW7)

For further details refer to Page 4-5.

4.5 ADJUSTMENT OF REFERENCE PRINT POSITION

You can use potentiometer VR4 for adjusting the offset (label stop position) by +/- 3.75 mm, as shown below.

Adjustment of Reference Position for Printing

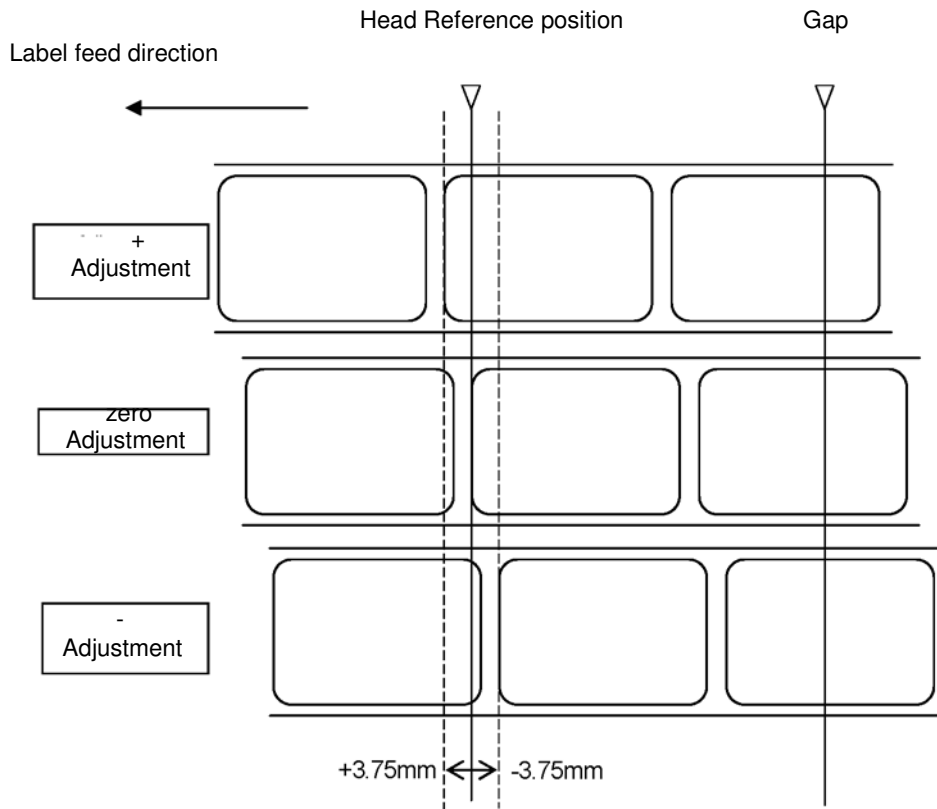

Note:

When the Gap sensor is active, the stop position is indicated by the line marked "Gap" in the illustration above.

Label feed direction

4.6 ADJUSTMENT OF STOP POSITION FOR CUTTER, PEEL OFF AND TEAR-OFF MODES

You can use potentiometer VR1 (with DSW set to OFF) for adjusting the label stop position when options such as Cutter, Dispenser, Tear-off, etc, are installed. Adjustment range is by +/- 3.75 mm, as shown below.

Adjustment of Reference Position for Cutting

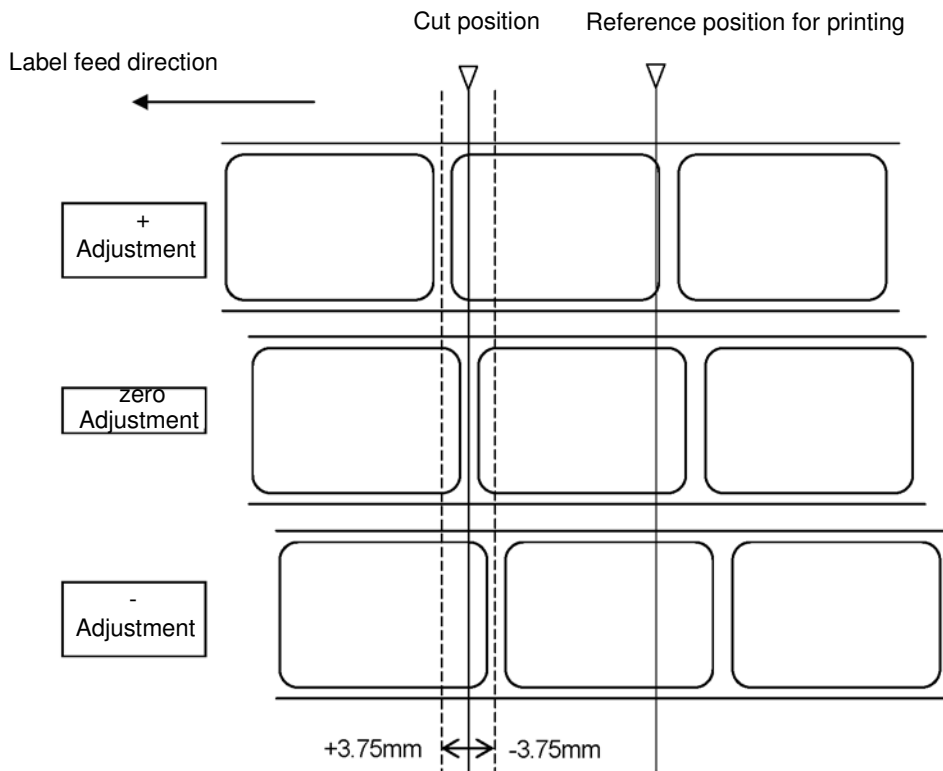

Note:

When DSW6 is ON, no adjustment of reference position is allowed.

1. tion is at the desired location on the label.
2. Press the FEED button to stop printing.

Note:

Adjusting the Label Pitch with VR1 will affect the stop position of the label and the cut/tear-off positions.

4.7 POTENTIOMETER ADJUSTMENTS

Print Darkness

A fine adjustment for PRINT DARKNESS can be made using potentiometer VR1 on the Front Operator Panel. It provides a continuous range of adjustment, allowing you to make precise changes. Turning VR1 clockwise will make the print darker, and counterclockwise will make it lighter.

1. Place DSW6 on the Configuration Switch in the ON position.
2. Turn the Power Switch OFF.
3. While pressing the FEED button on the Operator Panel, turn the Power Switch ON.
4. When you hear one beep from the printer, release the FEED button.
5. Press the LINE button to begin printing large Test Labels (press the FEED button if you are using labels smaller than 4.1" (104 mm) in width).
6. Adjust potentiometer VR1 until the desired print darkness is obtained.
7. Press the FEED button to stop the printing.

4.8 DATA DUMP DIAGNOSTIC LABEL

The contents of the printer buffer can be examined using the DATA Dump mode. This printout labels each line of the received data in the left hand column, the data in the middle column followed by the same data in ASCII format in the right-hand column.

1. Turn the printer OFF.
2. Place DSW7 on the configuration Switch in the ON position.
3. Turn the printer ON.
4. Transmit data to the printer.
5. The data received is printed on the label.
6. Place DSW7 in the OFF position.
7. Turn the printer OFF and then back ON to place it back in the normal print mode.

```

000007D0 7031393130591B26 6131383050515459 p1910Y%&a180PQTY
000007E0 201B287339563330 1B266130501B2A76 % (s9V30%&a0P%*v
000007F0 541B2839551B2873 3431343874306230 T% (9U% (s4148t0b0
00000800 73362E3030763150 1B2A703137393058 s6, 00v1P%*p1790X
00000810 1B2A703138353059 1B26613138305055 %*p1850Y%&a180PU
00000820 5345204245464F52 45201B2873395631 SE BEFORE % (s9V1
00000830 302F31322F30351B 266130501B2A7654 0/12/05%&a0P%*vT
00000840 1B2839551B287334 3134387430623073 % (9U% (s4148t0b0s
00000850 332E30307631501B 2A70353734581B2A 3, 00v1P%*p574X%*#
00000860 7032303536591B26 61313830501B2661 p2056Y%&a180P%&a
00000870 30501B2A76541B28 39551B2873343134 0P%*vT% (9U% (s414
00000880 387430623073332E 30307631501B2A70 8t0b0s3, 00v1P%*p
00000890 353839581B2A7032 303536591B266131 589X%*p2056Y%&a1
000008A0 3830501B26613050 1B2A76541B283955 80P%&a0P%*vT% (9U
000008B0 1B28733431343874 30623073372E3030 % (s4148t0b0s7, 00
000008C0 7631501B2A703232 33581B2A70313530 v1P%*p223X%*p150
000008D0 33591B2661313830 5031302F31322F30 3Y%&a180P10/12/0
000008E0 341B266130501B2A 76541B2839551B28 4%&a0P%*vT% (9U% (
000008F0 7334313438743062 3073362E30307631 s4148t0b0s6, 00v1
00000900 501B2A7034393358 1B2A703137373959 P%*p493X%*p1779Y
00000910 1B2661313830501B 287336564D464720 %&a180P% (s6VMFG
00000920 1B28733956422D44 1B266130501B2A76 % (s9VB-D%&a0P%*v
00000930 541B2839551B2873 3431343874306230 T% (9U% (s4148t0b0
00000940 73392E3030763150 1B2A70353532581B s0, 00v1P%*p552X%
00000950 2A7031393138591B 2661313830501B26 *p1918Y%&a180P%&
00000960 6130501B2A76541B 2839551B28733431 a0P%*vT% (9U% (s41
00000970 3438743062307336 2E30307631501B2A 48t0b0s6, 00v1P%*
00000980 70353532581B2A70 32303538591B2661 p552X%*p2058Y%&a
00000990 313830501B266130 501B2A76541B2839 180P%&a0P%*vT% (9
000009A0 551B287334313438 7433623073362E30 U% (s4148t3b0s6, 0
000009B0 307631501B2A7035 3934581B2A703134 0v1P%*p594X%*p14
000009C0 3538591B26613138 3050201B26613050 58Y%&a180P %&a0P
000009D0 4034705440000055 4000700400000071 5+ % (01% (4100

```

Note:
 Depending on the version of your printer's onboard software, the appearance of your test printout may be different from that shown here.

4.9 PRINTING TEST LABELS

1. The User Test Label prints the current default settings of the printer.
2. Press the FEED button while turning the power ON.
3. When the printer beeps, release the FEED button.
4. To print a large (4" wide) test label, press the ON LINE button. To print a small (2" wide) test label, press the FEED button.
5. The printer will continuously print the USER TEST LABEL until the FEED button is pressed. If the FEED button is pressed another time, printing will resume.
6. To remove the printer from the Test Label mode, power the printer OFF.

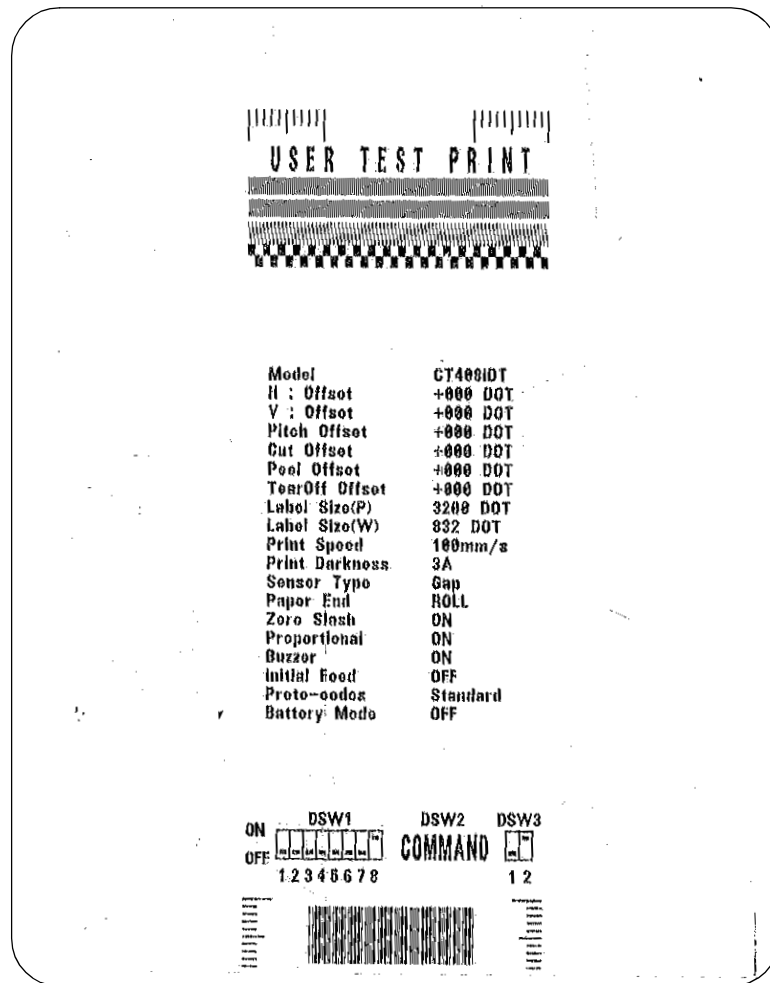

Note:

Depending on the version of your printer's onboard software, the appearance of your test printout may be different from that shown here.

4.10 PRINTING FACTORY/SERVICE TEST PRINTS

The Factory/Service Test Label prints the internal operating parameters of the printer.

1. Release the print head. (see "Releasing/Replacing the Print Head on page 4-4).
2. Press the LINE and FEED buttons while turning the printer ON.
3. When the printer beeps, release the LINE and FEED buttons. The printer will then beep 3 times indicating it is in the Factory/Service Print Test mode.
4. Re-latch the Print Head.
5. Press the LINE button to print a large (4" wide") Factory/Service Test Label. Press the FEED button to print a small (2" wide) Factory/Service Test Label.
6. The printer will begin printing a series of test labels, the first containing the operational parameters of the printer followed by one containing the internal printer settings. These two label formats will alternate until the FEED button is pressed, suspending the print operation. If the FEED button is pressed again, the printing will resume.

To remove the printer from the Factory/Service Print Test mode, remove power by placing the POWER switch in the OFF position.

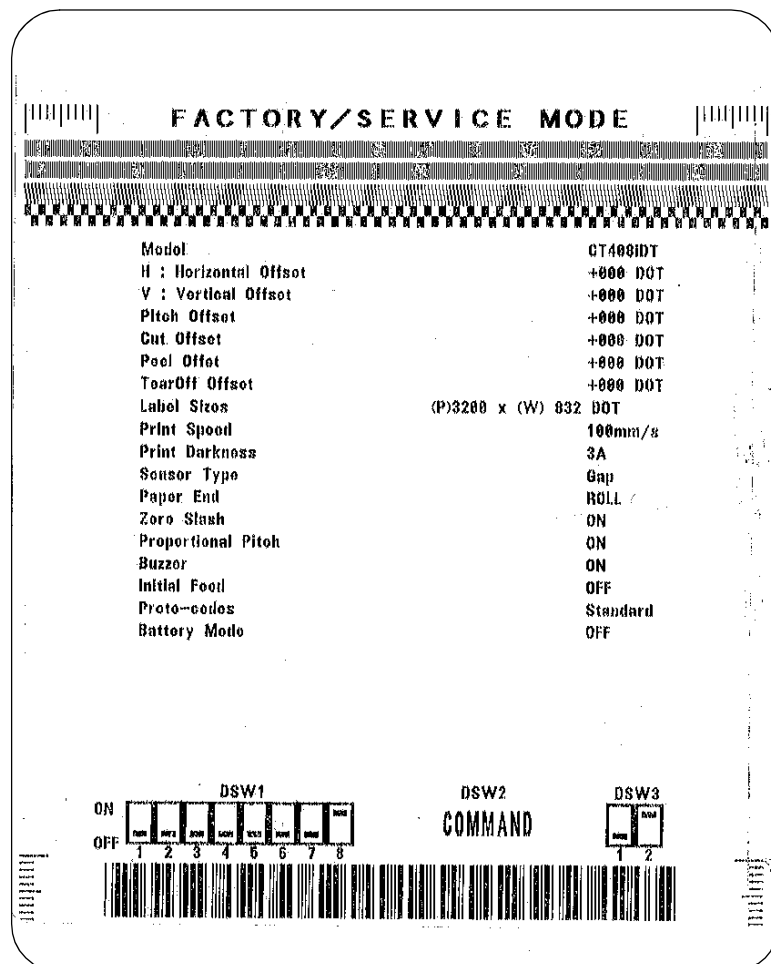

Note:

Depending on the version of your printer's onboard software, the appearance of your test printout may be different from that shown here.

5

TROUBLESHOOTING

- **Troubleshooting Guide**
- **Interface Troubleshooting**
- **Test Print Troubleshooting**

TROUBLESHOOTING GUIDE

Display	ON ERROR	BUZZER	ERROR CONDITION	CORRECTIVE ACTION
<i>0</i>	ON	1 Beep	Flash Memory error	Consult your SATO dealer
<i>1</i>			Not Assigned	
<i>2</i>	ON	1 Beep	Machine Error	Consult your SATO dealer
<i>3</i>	ON	1 Beep	EEPROM Error	Replace EEPROM
<i>4</i>	ON	1 Beep	Electrical Head error	Replace Print Head or consult your SATO dealer
<i>5</i>	Blink	3 Beeps	Head Not Latched	Latch Print Head securely and make sure the Top Cover is closed properly
<i>6</i>	Blink	3 Beeps	Out of Paper	1) Replenish paper supply 2) Route paper through sensor correctly
<i>7</i>	Blink	3 Beeps	Sensor error	1) Adjust sensor level
<i>8</i>	Blink	3 Beeps	Cutter error	Connect cutter (optional item) properly or consult your SATO dealer
<i>8.</i>	ON		Program Error	Resend data to the printer
<i>9</i>	ON	3 Beeps	Ribbon End	Check ribbon loading and/or load a new ribbon roll (TT model only)
<i>A</i>	ON	1 Beep	Receive Buffer Overflow	1) Restart the printer and retry 2) Modify host SW 3) Select correct communication protocol settings
<i>b</i>	ON	1 Beep	Parity error (Serial I/F only)	Correct the Parity Settings or consult your SATO dealer
<i>c</i>	ON	1 Beep	Framing Error (Serial I/F only)	Check and correct the data bit setting and retry
<i>d</i>	ON	1 Beep	Overrun Error (Serial I/F only)	Check and correct the flow control settings and retry
<i>E</i>	ON	1 Beep	LAN Time Out Error	Check the Interface Card and all associated connections to/from it. Replace if necessary
<i>F</i>		3 Beeps	Font/graphic Data Error (Serial I/F only)	Recheck and correct the data stream and retry
<i>r</i>			RFID Error	Check the RFID equipment and media
<i>H</i>		3 Beeps	Error in Kanji Character ROM	Consult your SATO dealer

Unit 5: Troubleshooting

Display	ON ERROR	BUZZER	ERROR CONDITION	CORRECTIVE ACTION
L	blinks	No beep	Low Battery level	Check the battery level and recharge or replace the battery as necessary
	steady	long beep	Critically Low Battery level	Replace or recharge the battery
⤵			USB interface selected	NA
L			Other interface selected	NA

Unit 5: Troubleshooting

TROUBLESHOOTING TABLE	
IMAGE VOIDS	
Dirty print head	Clean print head
Damaged print head	Replace print head
Damaged electronics	Replace circuit board
Damaged or worn roller	Replace rollers
Poor label quality	Use higher quality media
Ribbon stock and media are mismatched	Consult with media supplier. Use only SATO-certified media
RIBBON WRINKLING	
Poor head alignment	Adjust head balance and alignment
Excessive temperature setting	Adjust temperature
Poor ribbon tension	Adjust tension as required
Worn roller	Replace as necessary
Foreign material on print head and/or rollers	Clean as required
Foreign material on labels	Use higher quality media
Damaged print head	Replace print head as required
LIGHT PRINT IMAGES	
Low print head energy/darkness	Adjust darkness level
Low print head pressure	Adjust head pressure and/or balance
Foreign material on print head	Clean print head and rollers
Improper head alignment	Align print head as required
Excessive print speed	Reduce print speed setting
UNEVEN PRINT DARKNESS	
Unbalanced print head	Adjust head balance
Worn rollers	Replace rollers as required
Dirty print head	Clean print head
MEANDERING MEDIA	
Incorrectly loaded media	Ensure correct loading
Improperly adjusted media guides	Adjust as required
Unbalanced print head	Adjust as required
Worn rollers	Replace as required
NO LABEL MOVEMENT	
Loose or broken timing belt	Replace or adjust as required
Incorrect label sensor selected	Check printer configuration for proper sensor selection
No voltage output	Replace fuse. Test power supply and replace as required
Drive motor not operating	Ensure wiring harness connection. Replace as necessary
LED FIELD ILLUMINATED BUT NO DISPLAY AT ALL	
Power supply issues	Ensure cable properly connected. Check/replace power supply
Incorrectly positioned display potentiometer.	Adjust as required

Unit 5: Troubleshooting

NO PRINTED IMAGE	
Print head is disconnected.	Ensure print head wiring harness is connected on each end.
No voltage output	Replace fuse. Test power supply and replace as required
Defective print head	Replace print head and reset counter
Damaged electronics	Replace circuit board
Interface problems	Troubleshoot interface - refer to the next chapter
Data input error	Ensure correct data stream
PRINTER CREATES A BLANK LABEL	
Data input error	Ensure correct data stream
Incorrect label sensor selection	Ensure correct printer configuration
Disconnected print head	Power off the printer and ensure a proper connection
Defective print head	Replace print head as required
Defective main circuit board	Replace main board as required
INCORRECT LABEL POSITIONING	
Incorrect label sensor selection	Ensure correct printer configuration
Improper sensor adjustment	Adjust sensor sensitivity as required
Data input error	Ensure correct data stream
Incorrect offset settings	Adjust settings as required
SMEARED PRINT IMAGES	
Poor media quality	Use higher quality media
Foreign material on print head and platen roller	Clean print head and rollers
Foreign material on labels	Use higher quality media
Excessive print head energy	Adjust darkness setting
Excessive print speed	Adjust print speed as required

INTERFACE TROUBLESHOOTING

This chapter provides a checklist for the various interface types. Locate the checklist relative to the interface used and perform each of the troubleshooting tasks until the problem has been isolated.

PARALLEL INTERFACE	
CHK	TROUBLESHOOTING STEP
	Ensure the interfaces or interface card are correctly installed. Run self-test to verify.
	Ensure the printer cable is connected to the appropriate LPT port on the host computer. If using a Windows printer driver, ensure the correct port is selected.
	Ensure a IEEE1284 printer cable is being used.
	Ensure the host's peripheral settings are set to ECP for faster throughput. Refer to the computer manufacturer's documentation for details.
	Ensure the printer is receiving information from the computer using the Receive Buffer Hex Dump mode. Refer to that procedure within this manual for instructions. The command stream should be continuous and possess 0Dhex and/or 0Ahex (carriage return and line feed) characters throughout. However, there should not be either located between the start (<ESC>A and the stop (<ESC>Z) commands.
	Try another port to isolate the problem.
	Replace the main circuit board if determined to be the problem.

RS232 SERIAL INTERFACE	
CHK	TROUBLESHOOTING STEP
	Ensure the correct interface module is correctly installed. Run self-test to verify.
	Ensure the serial cable (Null Modem) meets specifications and is correctly connected at each end.
	Ensure the serial cable is not defective.
	Ensure the communication parameters for the baud rate, parity, data bits and stop bits are consistent with those being sent from the host computer.
	Ensure the printer is receiving information from the computer using the Receive Buffer Hex Dump mode. Refer to that procedure within this manual for instructions. The command stream should be continuous and possess 0Dhex and/or 0Ahex (carriage return and line feed) characters throughout. However, there should not be either located between the start (<ESC>A and the stop (<ESC>Z) commands.
	Try another port to isolate the problem.
	Replace the main circuit board if determined to be the problem.

UNIVERSAL SERIAL BUS (USB) INTERFACE	
If nothing prints during a test print, verify the device drivers have been successively installed by performing the following:	
CHK	TROUBLESHOOTING STEP
	Click on Start, Settings, and then Control Panel.
	Click on System within the new window.
	Click on the Device Manager tab.
	Ensure that the View Device By Type is checked.
	Scroll to SATO-USB Device and ensure that errors do not exist. Reinstall as required.
	Reboot the PC and the printer.

LAN ETHERNET INTERFACE

CHK	TROUBLESHOOTING STEP
	Ensure the interface has been correctly configured. Wait two minutes and run self-test to verify. If a test label does not print, there may be a hardware problem.
	Ensure the cable and its ports are not defective.
	Ensure that a faulty print server or other protocol related scenarios are not creating a queue setup issue. Systematically perform checks and tests to isolate the cause.
	If using TCP/IP, ensure a valid IP address is specified and that all parameters are correct (subnet mask, gateway, etc.). Attempt to PING the IP address assigned to the network interface.
	If using a repeater or hub, ensure the SQE is turned off. Also ensure the repeater port is not defective by trying the print server on another port.
	Install the IPX/SPX protocol on a workstation to determine if the network device can be discovered via the MAC address. If able, configure the appropriate protocols and retest connectivity.
	Use a crossover cable to isolate the printer from the network by connecting from the interface and workstation. Verify that the parameters match on each. Test connectivity.

802.11G WIRELESS INTERFACE

CHK	TROUBLESHOOTING STEP
	Ensure the antenna is properly and completely installed.
	Ensure the wireless card is properly installed.
	Ensure the green connection lights on the back of the interface board are illuminated.
	If not obtaining an IP address, check the SSID or encryption and ensure those were properly entered.
	To determine the IP address obtained through the DHCP wireless device, power off the printer, place switch 3 in the upward position on the wireless card and reinsert it into the printer, and power the printer on. Wait approximately 30 seconds for a print out of configurations.

CENTRONICS INTERFACE

CHK	TROUBLESHOOTING STEP
	Ensure the interface module is correctly installed. Run self-test to verify.
	Ensure the printer cable is connected to the appropriate LPT port on the host computer. If using a Windows printer driver, ensure the correct port is selected.
	Ensure the host's peripheral settings are set for Centronics output for faster throughput. Refer to the computer manufacturer's documentation for details.
	Ensure the printer is receiving information from the computer using the Receive Buffer Hex Dump mode. Refer to that procedure within this manual for instructions. The command stream should be continuous and possess 0D Hex and/or 0A Hex (carriage return and line feed) characters throughout. However, there should not be either located between the start (<ESC>A and the stop (<ESC>Z) commands.
	Replace the main circuit board with another to isolate the problem.

TEST PRINT TROUBLESHOOTING

Chapter provides instruction on special printing to identify and resolve specific print problems.

HEX DUMP

Allows the operator to determine if there were problems in the downloading of data. The contents of the print buffer can be examined using the Hex Dump Mode. In the left column, each line of data received is numbered. The center column provides the data in hexadecimal format. And in the right column, same data is provided in the ASC II format. Follow the flow chart provided below to perform this activity.

TEST LABEL PRINTING

Allows the operator to identify specific problems regarding mechanical performance and setup. The test label is designed to assist in the identification of print problems. Follow the flow chart provided below to perform this activity.

Check resolution and label path here

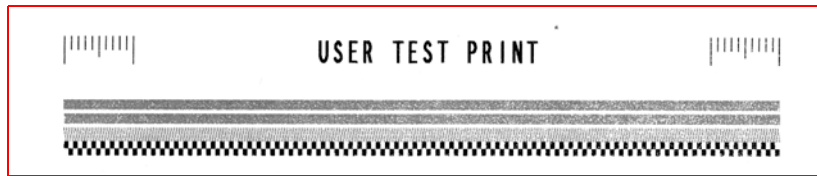

Machine Type	2500-500
H : Horizontal Offset	+000 DOT
V : Vertical Offset	+000 DOT
Pitch Offset	+000 DOT
Cut Offset	+000 DOT
TearOff Offset	+000 DOT
Label Size	(P)4800 x (W)1248 DOT
Print Speed	100mm/s
Print Darkness	3A
Sensor Type	Gap
Paper End	ROLL
Zero Slash	ON
Proportional Pitch	ON
Buzzer	ON
Initial Feed	OFF
Proto-codes	Standard
Interface	USB
Buffer Type	Multi
Protocol	None

List of Operational and Media Settings

List of DIPSW Current Settings

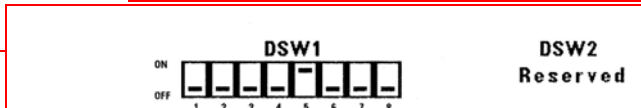

Check print quality and print head status here

Figure 6-2, Sample Test Label

6

MAINTENANCE

- **Cleaning Procedures**
- **Replacement Procedures**
- **Adjustment Procedures**

CLEANING PROCEDURES

Cleaning of the printer is a necessary maintenance activity to ensure print quality and longer printer life. There are two basic types of cleaning involved; the removal of loose debris and the removal of residue.

Use a soft cloth and/or a pneumatic blower to remove debris from the printer. This process should be performed prior to the removal of residue. To remove residue, apply SATO Solvent (available separately) or isopropyl alcohol to a clean cotton swab and gently wipe the entire surface of the print head and platen roller clean.

Of particular importance is the care and maintenance of Print Heads. Efforts should be made to educate printer operators and their supervisors to refer to this Operator's Manual or other relevant documentation when cleaning the print head, platen and rollers. Regular cleaning regimes should be enforced to make sure that the printer and the immediate production area are cleaned regularly to minimize dust buildup. Properly adjustment of the print head balance should be done periodically, and the use of certified SATO consumables will maximize output quality and minimize print head replacement. For pre-printed labels, ensure that ad-hoc testing is conducted so that the materials are print-head safe.

Finally, efforts should be made to ensure that operators and their supervisors do not compensate for print quality problems by adjusting print darkness/print speed settings unnecessarily. When print heads show signs of problems, do not allow them to continue being used. To this end, SATO Service Contracts are highly recommended, to help businesses to reduce downtime while maximizing the durability and usable life of the printer.

WARNING: DISCONNECT POWER TO THE PRINTER AND ALLOW THE LATTER TO COOL TO ROOM TEMPERATURE PRIOR TO CLEANING. EXCERSIZE CARE WHEN CLEANING TO PREVENT PERSONAL INJURY.

CAUTION: IF USING A PNEUMATIC BLOWER TO REMOVE DEBRIS FROM THE PRINTER, EXCERSIZE CARE TO PREVENT PRINT HEAD DAMAGE.

Figure 6-1, Print Head Replacement

ADJUSTMENT PROCEDURES

This section provides information on user maintenance for the SATO CT4i printer. This section contains the following information.

- Adjusting the Print Quality
- Cleaning the Print Head, Platen and Rollers
- Replacing the Print Head

ADJUSTING THE PRINT QUALITY

The SATO CT4i printer is equipped with two different methods of adjusting the quality of the print—**print darkness** and **print speed**.

When adjusting the printer for optimum print quality, a barcode verifier system is highly recommended for evaluating the printouts. The human eye is a poor judge of the relative widths of the bars in a symbol, a characteristic that is extremely important for good bar code quality.

Print Darkness

This adjustment allows the user to control (within a specified range) the amount of power that is used to activate the print head heating elements. It is important to find a proper print darkness level based on your particular label. The printed images should not be too light nor should the edges of text or graphics be smudged. Instead, the edges of each image should be crisp and well defined.

Once the range has been selected, the PRINT Potentiometer (VR1) on the front panel can be used to make finer adjustments. It provides a continuous range of adjustment, allowing you to make precise changes. Use a small cross-point screwdriver, turning clockwise for darker print and counterclockwise for lighter print. See page 3-3 for instructions on performing potentiometer adjustments

Print Speed

The other method of controlling print quality is by controlling the speed at which the label is printed. It is especially critical when printing "ladder" bar codes (bar codes printed with the bars parallel to the print line). When printing a "ladder" bar code, it is important to allow the head to cool sufficiently before stepping to the next position. If it does not have sufficient time to cool, the bar will be "smeared" on the trailing edge. The adjustment can be made via standard SBPL commands. For more information refer to the SBPL Programming Reference.

CLEANING THE PRINT HEAD, PLATEN AND ROLLERS

Cleaning the Print Head

1. Before starting, get ready an approved cleaning kit from your SATO dealer or the kit supplied with the printer. Make sure the printer is OFF, and remove the power cable.
2. Lift up the Top Cover and locate the Print Head Assembly which is mounted under the cover.
3. Apply Thermal Print Head Cleaner to a cotton swab.
4. The Print Head faces downward along the front edge of the assembly. Pass the end of the dampened swab along the entire width of the Print Head.
5. Check for any black coloring or adhesive on the swab after cleaning.
6. Repeat if necessary until the swab is clean after it is passed over the head.
7. The head should be cleaned at least every time the label roll is changed, and more often in harsh environments.



Figure 6-1, Cleaning the print head

Cleaning Stubborn Debris on the Print Head

1. If certain stains on the print head cannot be removed easily with cotton swabs dabbed in cleaning solution, obtain cleaning sheets designed for cleaning print heads (for such supplies, contact your SATO dealer).
2. Load the cleaning sheet with the rough side facing the print head. Follow any other instructions or precautions printed on any leaflet that may accompany the cleaning sheet.
3. With the printer turned OFF, and the Top Cover closed, slowly pull the cleaning sheet outwards. Repeat the process until the print head is clean.



Figure 6-2, Using the Cleaning Sheet

CLEANING THE PRINT HEAD, PLATEN AND ROLLERS (CONT'D)

Cleaning the Platen and Paper Roller

1. Before starting, get ready an approved cleaning kit from your SATO dealer or the kit supplied with the printer. Make sure the printer is OFF, and remove the power cable.
2. Lift up the Top Cover.
3. The platen roller is the black rubber roller near the front panel. The print rollers are located at the print head assembly, near the fanfold-label loading window.
4. Wet some cotton swabs with cleaning solution. While rotating the platen roller with your fingers, clean the entire length of the roller using one or more cotton swabs. The roller should be cleaned of any label or adhesive residue.
5. Repeat the whole cleaning process if necessary. The platen and rollers should be cleaned whenever foreign matter such as dust or adhesive is present.

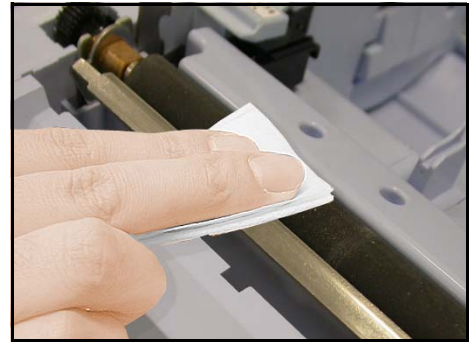

Figure 6-4, Cleaning the platen

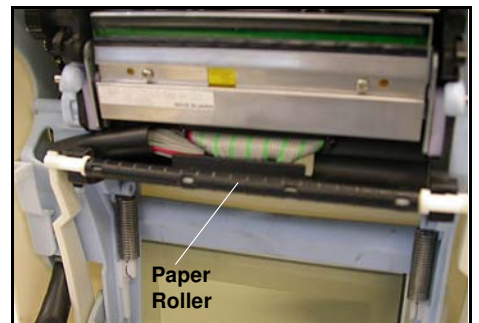
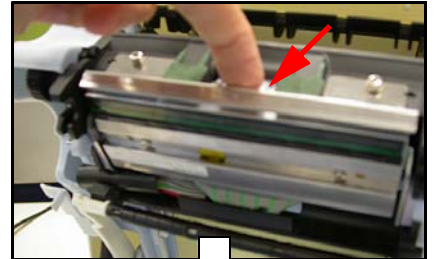

Figure 6-4, Cleaning the rollers

RELEASING/REPLACING THE PRINT HEAD

The print head on the printer is a user-replaceable item. If it becomes damaged for any reason, it can be easily removed and replaced. Contact your local SATO representative for information on obtaining a new print head. You will also need a No. 2 Phillips screwdriver (a magnetic tip is helpful) for the replacement procedure.

1. Make sure the printer is OFF, and remove the power cable.
2. Lift up the Top Cover.
3. Locate the small center tab (see red arrow) above the print head. Press and hold down this tab. At the same time, pull the whole print head below it, downwards if it does not drop downwards automatically.



The cable connector (circled red here) at the rear of the print head is now exposed. Pull the print head downwards, then gently disconnect the print head from the cable.

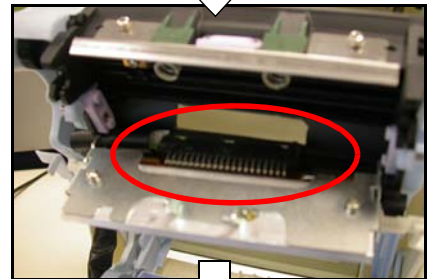

4. Carefully attach a replacement print head to the cable connector. The connectors are keyed so that they can only be inserted in the correct orientation.

Note:

While handling the print head, be careful not to scratch the printing surface of the print head. Scratching the surface will cause permanent and irreparable damage that is not covered by the warranty!



5. Reinsert the print head into the printer, making sure that the metal slots at the two sides of the print head fit back over the round purple pivots on the printer (see circled area here).
6. Press and hold down the center tab (see red arrow) which was previously used to release the print head. Push the print head upwards so that it snaps into place.

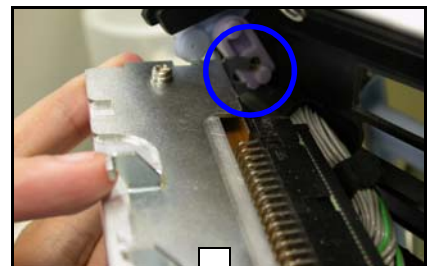

7. Release the center tab and close the Top Cover. Proceed to perform a test print to ensure that the print head is connected properly.



CLEANING THE SENSOR

The I-Mark and gap sensors are used to control the positioning of the label. The gap sensor is a transmissive see-thru sensor that detects the edge of the label by sensing through the backing paper which is translucent and detecting the presence of the opaque label. The I-Mark sensor detects the black I-Mark found on I-Mark labels.

So when dust, dirt or other foreign matter interferes with the light path of the any sensor, erratic label positioning occurs. The sensors, both housed in the same area, should thus be cleaned regularly, after every two rolls of labels.

1. Turn the printer OFF and remove the power cable.
2. Open the Top Cover.
3. Locate the sensor located next to the yellow screwdriver, near the left-hand side label guide so that it moves whenever the Label Guide are adjusted for different media widths.
4. Apply Thermal Print Head Cleaner to a cotton swab.
5. Use the cotton swab to clean any foreign matter from the exposed surface of the sensor by inserting the cotton tip in the paper slot and briskly cleaning it with a back and forth motion.

